

Installation & Operation Manual

KBAC SERIES

Adjustable Frequency Drives for 3-Phase AC Motors
NEMA 4X / IP65

Variable Speed/Soft-Start AC Motor Drive
with Electronic Motor Overload Protection¹

Washdown and Watertight for Indoor and Outdoor Use
Rated for 208 – 230, and 400/460 Volt 50 & 60 Hz
3-Phase & PSC² AC Induction Motors from Subfractional thru 10 HP

Operates from 115, 208/230 and 400/460 Volt 50/60 Hz AC Line³

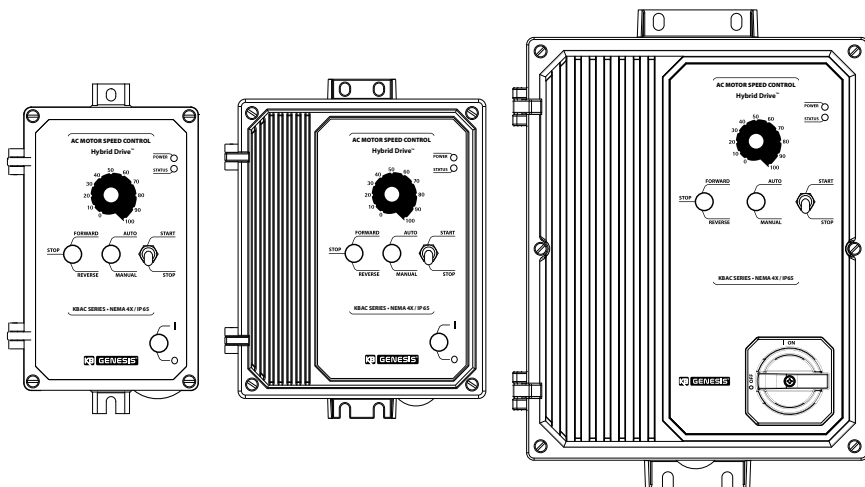

This Manual Covers Models

KBAC-24D, 27D, 29, 29 (1P), 45, 48, 217, 217S, 217F, 217SF, 416, 416S, 416F, 416SF



See Safety Warning
on Page 6.



NOTE: THE DRIVE IS FACTORY SET FOR 60 Hz MOTORS. FOR 50 Hz MOTORS, SEE SECTION 6.4 ON PAGE 24.

The information contained in this manual is intended to be accurate. However, the manufacturer retains the right to make changes in design which may not be included herein.

Notes: 1. UL approved as an electronic overload protector for motors. 2. Special software is available – contact our Sales Department. 3. GFCI Operation: Models KBAC-24D, 27D, 29, 29 (1P), 45, 48 require custom software – contact our Sales Department. The KBAC-217, 416 Series are jumper selectable (J12) for standard (G1) and sensitive (G2) GFCIs. 4. Installation of a CE approved RFI filter is required.



Automation and Control

Table of Contents

Section	Page
1 Quick-Start Instructions	4
2 Safety Warning	6
3 Introduction	6
4 Important Application Information	18
5 Wiring Instructions	18
6 Setting Selectable Jumpers	23
7 Mounting Instructions	26
8 Recommended High Voltage Dielectric Withstand Testing (Hi-Pot Testing)	26
9 Reconditioning the Bus Capacitors	26
10 Drive Operation	28
11 AC Line Fusing	28
12 Diagnostic LEDs	28
13 Trimpot Adjustments	29
Appendix A – Optional SIAC-PS Signal Isolator with Power Supply	33
Limited Warranty	36
Tables	Page
1 Jumper Selectable Features	8
2 Optional Accessories	9
3 General Performance Specifications	13
4 Electrical Ratings	14
5 Terminal Block Wiring Information	19
6 Drive Operating Condition and Run/Fault Relay Contact Status	23
7 Drive Operating Condition and Status LED Indicator	29
Figures	Page
1 Quick-Start Connection Diagram	4
2 KBAC-24D Control Layout	10
3 KBAC-27D, 29, 29 (1P), 45, 48 Control Layout	11
4 KBAC-217, 416 Series Control Layout	12
5 Model KBAC-24D Mechanical Specifications	15
6 Models KBAC-27D, 29, 29 (1P), 45, 48 Mechanical Specifications	16
7 KBAC-217, 416 Series Mechanical Specifications	17
8 Maximum Allowed Motor Torque vs. Speed	18
9 Open Ventilated Motor with External Fan Cooling	18
10 Models KBAC-24D, 27D, 29 (1P), AC Line Input, Motor, and Ground Connections	20
11 Models KBAC-29, 45, 48 AC Line Input, Motor, and Ground Connections	20
12 KBAC-217, 416 Series AC Line Input, Motor, and Ground Connections	20
13 Remote Main Speed Potentiometer Connection	21
14 Remote Start/Stop Switch Connection with Normally Open Stop Contact	21
15 Remote Start/Stop Switch Connection with Normally Closed Stop Contact	21
16 Start/Stop Function Eliminated	22
17 Voltage Following Connections	22
18 Enable Circuit Connection	22
19 Run/Fault Relay Output Contacts Connection	23
20 Models KBAC-24D, 27D AC Line Input Voltage Selection (Jumper J1)	23
21 Removing Jumper J1 on Models KBAC-24D, 27D	23
22 Motor Horsepower Selection (Jumper J2)	24
23 Automatic Ride-Through or Manual Restart Selection (Jumper J3)	24

24 60 Hz and 50 Hz Motor Selection (Jumpers J4 and J5) 24

25 Available Torque vs. Output Frequency 24

26 120 Hz and 100 Hz Drive Output Frequency Selection 25

27 Fixed or Adjustable Boost Selection (Jumper J6). 25

28 Regenerative or DC Injection Braking Selection (Jumper J7) 25

29 “Run” or “Fault” Output Relay Operation Selection (Jumper J8). 25

30 Normally Open or Closed Stop Contact Selection (Jumper J9) 25

31 Constant or Variable Torque Selection (Jumper J10) 25

32 Switching Frequency and GFCI Selection (Jumper J12) 26

33 Typical Hi-Pot Test Setup. 27

34 Minimum Speed Trimpot (MIN) Range 30

35 Maximum Speed Trimpot (MAX) Range 30

36 Acceleration Trimpot (ACCEL) Range 30

37 Deceleration Trimpot (DEC/I) Range 30

38 DC Injection Brake Trimpot (DEC/I) Range. 30

39 Slip Compensation Trimpot (COMP) Range 30

40 Current Limit Trimpot (CL) Range 30

41 I²t Trip Time vs. Motor Current 31

42 Boost Trimpot (BOOST) Range 31

43 Jog Trimpot (JOG) Range Run-Stop-Jog Switch Connection 32

44 Run-Stop-Jog Switch Connection 32

Items Included In this Package:

Adjustable Frequency Drive, Installation and Operation Manual, Trimpot Adjustment Tool, CE Approved Product Information Card, and Warranty Registration Card.

Drive Model Nos. and Part Nos.

Model No.	Part No.	
	Gray	White*
KBAC-24D	9987	9988
KBAC-27D	9520	9521
KBAC-29	9528	9529
KBAC-29 (1P)	10001	10002
KBAC-45	9530	9531
KBAC-48	9540	9541

Model No.	Part No.	
	Gray	White*
KBAC-217	8868	8879
KBAC-217S	8863	8855
KBAC-217F	8861	8853
KBAC-217SF	8869	8880
KBAC-416	8870	8881
KBAC-416S	8864	8856
KBAC-416F	8874	8883
KBAC-416SF	8871	8882

*White FDA approved finish.

UL Notice

230 VAC Controls
 Suitable For Use on a Circuit Capable of Delivering Not More Than 5 kA RMS Symmetrical Amperes, 230 Volts Maximum.
 Use Copper Conductors Rated 75 °C.
 Suitable for Operation in a Maximum Surrounding Air Temperature of 40 °C.

460 VAC Controls
 Suitable For Use on a Circuit Capable of Delivering Not More Than 5 kA RMS Symmetrical Amperes, 460 Volts Maximum.
 Use Copper Conductors Rated 75 °C.
 Suitable for Operation in a Maximum Surrounding Air Temperature of 40 °C.

1 QUICK-START INSTRUCTIONS

Important – You must read these simplified instructions before proceeding. These instructions are to be used as a reference only and are not intended to replace the details provided herein. You must read the Safety Warning on page 5 before proceeding.

Reconditioning the Bus Capacitors – If this drive has been in storage for over one year, it is necessary to recondition the power supply bus capacitors. To recondition the bus capacitors, apply the AC Line with the drive in the Stop Mode for a minimum of one hour. Not following this procedure will cause the bus capacitors to fail.

See Figure 1. Also see Section 4 - Important Application Information on Page 18.



WARNING! Disconnect main power before making connections to the drive.

Figure 1 – Quick-Start Connection Diagram*

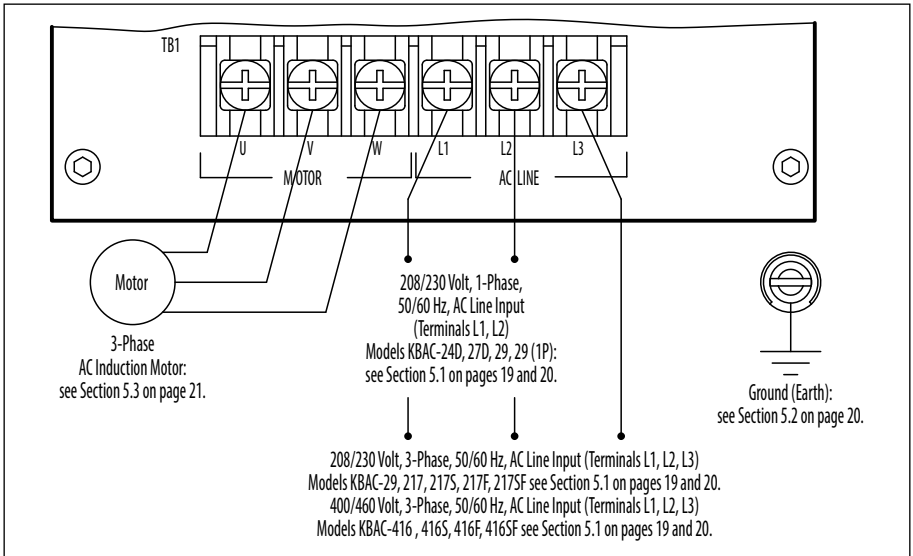

*Layout may vary.

1.1 AC Line Input Connection – Wire the AC Line input to Terminal Block TB1. See Section 5.1 on pages 19 and 20.

Application Note: GFCI Operation: Models KBAC-24D, 27D, 29, 29 (1P), 45, 48 require custom software – contact our Sales Department. The KBAC-217, 416 Series are jumper selectable (J12) for Standard (G1) or Sensitive (G2) GFCIs.

Note: The rated AC Line voltage of the drive must match the actual AC Line input voltage. On Models KBAC-24D and 27D, the setting of Jumper J1 must match the AC Line input voltage.

Models KBAC-24D, 27D, 29 (1P): Designed to accept 1-phase (Terminals L1, L2) AC Line input only. Rated for 208/230 Volt AC Line input with Jumper J1 set to the “230V” position (factory setting). Rated for 115 Volt AC Line input with Jumper J1 set to the “115V” position. See Figure 10 on page 20.

Note: Model KBAC-27D is rated for 1½ HP maximum with 115 Volt AC Line input and 2 HP maximum with 208/230 Volt AC Line input.

Model KBAC-29: Designed to accept 1-phase (Terminals L1, L2) or 3-phase (Terminals L1, L2, L3) AC Line input. Rated for 208/230 Volt AC Line input only. See Figure 11 on page 20.

Note: Rated for 2 HP maximum with 1-phase AC Line input and 3 HP maximum with 3-phase AC Line input. For 3 HP rating with single-phase input, use Model KBAC-29 (1P).

Models KBAC-217, 217S, 217F, 217SF: Designed to accept 3-phase (Terminals L1, L2, L3) AC Line input only. Rated for 208/230 Volt AC Line input only. See Figure 12 on page 20.

Models KBAC-45, 48, 416, 416S, 416F, 416FS: Designed to accept 3-phase (Terminals L1, L2, L3) AC Line input only. Rated for 400/460 Volt AC Line input only. See Figure 12 on page 20.

- 1.2 AC Line Fusing** – It is recommended that a fuse(s) or circuit breaker be installed in the AC Line. Fuse each conductor that is not at ground potential. For the recommended fuse size, see Table 4 on page 14. Also see Section 11 on page 28.
- 1.3 Ground Connection** – Connect the ground wire (earth) to the ground screw, as shown in Figures 10 -12 on page 20. See Section 5.2 on page 20.
- 1.4 Motor Connection** – Wire the motor to Terminal Block TB1 Terminals U, V, W, as shown in Figures 10 -12 on page 20. (Special reactors may be required for cable lengths over 100 ft. (30 m) – consult our Sales Department.) See Section 5.3 on page 21.
- 1.5 60 Hz And 50 Hz Motor Operation** – The drive is factory set for 60 Hz 3-phase motor operation (Jumper J5 set to the “60Hz” position). For 50 Hz motor operation, set Jumper J5 to the “50Hz” position. See Section 6.4 on page 24.
- 1.6 Start/Stop Switch** – The drive is supplied with a prewired Start/Stop Switch to electronically “start” and “stop” the drive, as described in Section 5.5 on page 21. This switch must be used to “start” the drive each time the AC Line is applied to the drive or to “restart” the drive. Also see Section 6.8 on page 25.
- 1.7 Jumper Settings** – All jumpers have been factory set for most applications. However, some jumpers may need to be set in order to tailor the drive for a specific application. See section 6 on pages 23 – 26.

IMPORTANT: In order to ensure that the motor is properly protected with the I²t Overload Protection feature, it is required that Jumper J2 is set to the corresponding position for the motor horsepower being used, as shown in Figure 22 on page 24.
- 1.8 Trimpot Settings** – All trimpots have been factory set for most applications. Some applications require adjustment of the trimpots in order to tailor the drive for a specific requirement. See Section 13 on pages 29 – 32.
- 1.9 Diagnostic LEDs** – After power has been applied, observe the LEDs to verify proper drive operation, as described in Section 12 on pages 28 and 29.

2 SAFETY WARNING

Definition of Safety Warning Symbols



Electrical Hazard Warning Symbol – Failure to observe this warning could result in electrical shock or electrocution.



Operational Hazard Warning Symbol – Failure to observe this warning could result in serious injury or death.



This product must be installed and serviced by a qualified technician, electrician, or electrical maintenance person familiar with its operation and the hazards involved. Proper installation, which includes electrical connections, fusing or other current protection, and grounding, can reduce the chance of electrical shocks, and/or fires, in this product or products used with this product, such as electric motors, switches, coils, solenoids, and/or relays. Do not use this drive in an explosion-proof application. Eye protection must be worn and insulated adjustment tools must be used when working with drive under power. This product is constructed of materials (plastics, metals, carbon, silicon, etc.) which may be a potential hazard. Proper shielding, grounding, and filtering of this product can reduce the emission of radio frequency interference (RFI) which may adversely affect sensitive electronic equipment. It is the responsibility of the equipment manufacturer and individual installer to supply this Safety Warning to the ultimate end user of this product. (SW 8/2012)



This product complies with all CE directives pertinent at the time of manufacture. Contact our Sales Department for Declaration of Conformity. Installation of a CE approved RFI filter is required. See RFI Filters & Chokes Selection Guide D-321 (Part No. A42027) for selection of filters that meet the Industrial or Residential Standard. Additional shielded cable and/or AC Line cables may be required along with a signal isolator (SIAC-PS).

3 INTRODUCTION

Thank you for purchasing the KBAC Adjustable Frequency Drive. KB Electronics, Inc. is committed to providing total customer satisfaction by producing quality products that are easy to install and operate. The KBAC is manufactured with surface mount components incorporating advanced circuitry and technology.

The drives are variable speed controls housed in a rugged NEMA 4X / IP65 washdown and watertight die-cast aluminum enclosure. They are designed to operate 208 – 230 and 400/460 Volt 50 & 60 Hz 3-phase AC induction motors from subfractional thru 10 HP. The sine wave coded Pulse Width Modulated (PWM) output operates at a carrier frequency of 16 kHz which provides high motor efficiency and low noise. Adjustable Linear Acceleration and Deceleration are provided, making the drive suitable for soft-start applications.

Due to its user-friendly design, the KBAC AC drive is easy to install and operate. Tailoring to specific applications is accomplished with selectable jumpers and trimpots, which eliminate the computer-like programming required on other drives. However, for most applications no adjustments are necessary.

Main features include adjustable RMS Current Limit and I²t Motor Overload Protection.* In addition, Adjustable Slip Compensation with Static Auto-Tune and Boost provides high torque and excellent load regulation over a wide speed range. Power Start™ delivers over 200% motor torque to ensure start-up of high frictional loads. Electronic Inrush Current Limit (EICL™) eliminates harmful AC Line inrush current. A Run/Fault Relay is provided, which can be used to turn equipment on or off, to signal a warning if the drive is put into the Stop Mode, or if a fault has occurred. The drive is suitable for machine or variable torque (HVAC) applications. Also, a jumper is provided for selection of Regenerative or DC Injection Braking.

Standard front panel features include Diagnostic LEDs for “Power On” and “Drive Status”, a Start/Stop Switch, and a Main Speed Potentiometer. Other features include a Barrier Terminal Block to facilitate wiring of the AC Line and motor, adjustable trimpots (MIN, MAX, ACCEL, DEC/I, COMP, CL, JOG, BOOST), customer selectable jumpers (Line Voltage - dual voltage models only), Motor Horsepower, Automatic Ride-Through / Manual Start, Motor Frequency, Frequency Multiplier, Fixed/Adjustable Boost, Regenerative / Injection Braking, “Run” or “Fault” Output Relay Operation, NO/NC Stop Contact, Constant/Variable Torque, Switching Frequency, and GFCI operation (KBAC-217 Series and KBAC-416 Series only).

Optional accessories include: Forward-Stop-Reverse Switch, On/Off AC Line Switch, Run-Stop-Jog Switch, Signal Isolator, Auto/Manual Switch, Class "A" AC Line Filter, Multi-Speed Board and Liquidtight Fittings. A connector is provided for easy installation of accessories. Custom software: all models can be factory programmed for applications which require special timing, PLC functions, and GFCI operation (Models KBAC-24D, 27D, 29, 29 (1P), 45, 48) – contact our Sales Department.

**UL approved as an electronic overload protector for motors.*

3.1 Standard Features

- **Industrial Duty Die-Cast Aluminum Case with Hinged Cover** – Available in Dark Gray finish or FDA approved white finish.
- **Simple to Operate** – Does not require programming. Uses trimpots and jumpers, which are factory set for most applications.
- **Motor HP Selection Jumper (J2)** – Allows the drive to be used on a wide range of motors without recalibration.
- **Switching Frequency and GFCI Selection Jumper (J12)** – Allows the drive to be operated at 8 kHz or 12 kHz and on Standard (G1) or Sensitive (G2) GFCIs. (KBAC-217 Series and KBAC-416 Series only.)
- **Diagnostic LEDs** – Power on (POWER) and drive status (STATUS).
- **Run/Fault Relay Output Contacts** – Can be used to turn equipment on or off, to signal a warning if the drive is put into the Stop Mode, or a fault has occurred.
- **Start/Stop Switch** – Provides electronic start and stop functions.
- **Barrier Terminal Block** – Facilitates wiring of motor, AC Line, and Run/Fault Relay Output Contacts.
- **Jumper Selection of Drive Output Frequency** – Increases the motor speed up to two times the rated RPM.
- **Ride-Through** – Provides smooth recovery to the previous set speed during a momentary power loss (of less than 2 seconds).
- **Holding Torque at Zero Speed** – Resists motor shaft rotation when the drive is in Stop Mode.

***Note:** GFCI Operation: Models KBAC-24D, 27D, 29, 29 (1P), 45, 48 require custom software – contact our Sales Department. The KBAC-217 Series and KBAC-416 Series are jumper selectable (J12) for Standard (G1) or Sensitive (G2) GFCIs.*

3.2 Performance Features

- **Power Start™** – Provides more than 200% starting torque which ensures startup of high frictional loads.
- **Slip Compensation with Static Auto-Tune and Boost** – Provides excellent load regulation over a wide speed range.
- **Speed Range** – 60:1

3.3 PROTECTION FEATURES

- **Motor Overload (I²t) with RMS Current Limit*** – Provides motor overload protection which prevents motor burnout and eliminates nuisance trips.*
- **Electronic Inrush Current Limit (EICL™)** – Eliminates harmful Inrush AC Line current during startup.
- **Short Circuit** – Shuts down the drive if a short circuit occurs at the motor (phase-to-phase).
- **Regeneration** – Eliminates tripping due to high bus voltage caused by rapid deceleration of high inertial loads.
- **Undervoltage and Overvoltage** – Shuts down the drive if the AC Line input voltage goes above or below the operating range.
- **MOV Input Transient Suppression** – Protects the drive components against damaging voltage spikes on the AC Line.
- **Microcontroller Self Monitoring and Auto Reboot.**

**UL approved as an electronic overload protector for motors.*

3.4 TRIMPOT ADJUSTMENTS

- **Minimum Speed (MIN)** – Sets the minimum speed of the motor. See Section 13.1 on page 29.
- **Maximum Speed (MAX)** – Sets the maximum speed of the motor. See Section 13.2 on page 29.
- **Acceleration (ACCEL)** – Sets the amount of time for the motor to accelerate from zero speed to full speed. See Section 13.3 on page 29.
- **Deceleration (DEC/I)** – Sets the amount of time for the motor to decelerate from full speed to zero speed. See Section 13.4 on page 27.
- **DC Injection Brake (DEC/I)** – When the drive is set for DC Injection Braking (Jumper J7 set to the “INJ” position), the DEC/I trimpot is used to set the DC Injection Brake voltage and time. See Section 13.5 on pages 29 and 30.
- **Slip Compensation (COMP)** – Maintains set motor speed under varying loads. See Section 13.6 on page 30.
- **Current Limit (CL)** – Sets the current limit (overload) which limits the maximum current to the motor. See Section 13.7 on pages 30 and 31.
- **Boost (BOOST)** – Sets the amount of Boost which can be used to obtain maximum low speed performance. See Section 13.8 on pages 31 and 32.
- **Jog (JOG)** – Sets the “jog” speed of the motor. Must be used with the optional Run-Stop-Jog Switch Kit (See Table 2 on page 9). See Section 13.9 on page 32.

Table 1 – Jumper Selectable Features

Description ¹	PC Board Designation	KBAC-24D, 27D	KBAC-29, 29 (1P), 45, 48	KBAC-217 Series KBAC-416 Series
AC Line Input Voltage (115, 230)	J1	✓	—	—
Motor Horsepower (see Table 4 - Electrical Ratings on page 14)	J2	✓	✓	✓
Automatic Ride-Through or Manual Restart (A ² , M)	J3	✓	✓	✓
Frequency Multiplier (1X, 2X)	J4	✓	✓	✓
Motor Frequency (50Hz, 60Hz)	J5	✓	✓	✓
Fixed or Adjustable Boost (FIX, ADJ)	J6	✓	✓	✓
Regenerative or DC Injection Braking (RG, INJ)	J7	✓	✓	✓
“Run” or “Fault” Output Relay Operation (R, F)	J8	✓	✓	✓
Normally Open or Closed Stop Contact (NO, NC)	J9	✓	✓	✓
Constant or Variable Torque (VT, CT)	J10	✓	✓	✓
Factory Use Only	J11	—	—	—
Switching Frequency and GFCl (8 kHz , 12 kHz, G1, G2)	J12	—	—	✓

Notes: 1. Bold indicates factory setting. 2. In Automatic Ride-Through Mode, the drive will automatically restart due to a momentary power loss of less than 2 seconds.

Table 2 – Optional Accessories

Description	KBAC-24D	KBAC-27D	KBAC-29	KBAC-29 (1P)	KBAC-45	KBAC-48	KBAC-217 Series KBAC-416 Series
Forward-Stop-Reverse Switch – Provides motor reversing and stop functions. Mounts on the enclosure cover and is supplied with a switch seal to maintain liquidtight integrity.	9480	9480	9480	9480	9480	9480	8888
On/Off AC Line Switch – Disconnects the AC Line. Mounts on the enclosure cover and is supplied with a switch seal to maintain liquidtight integrity.	9482	9523	9532	9532	9532	9532	“S” Suffix Models (Factory Installed Only)
Run-Stop-Jog Switch – Selects speed setting from either the Main Speed Potentiometer or the JOG Trimpot. Mounts on the enclosure cover and is supplied with a switch seal to maintain liquidtight integrity.	9340	9340	9340	9340	9340	9340	8889
SIAC-PS Signal Isolator with Power Supply – Provides isolation between a non-isolated signal source and the drive. Mounts on the drive’s PC board with four snap-ins.	9600C*	9600C*	9600C*	9600C*	9600C*	9600C*	8890
Auto/Manual Switch – When used with the Signal Isolator, it selects remote process signal or the Main Speed Potentiometer. Mounts on the enclosure cover and is supplied with a switch seal to maintain liquidtight integrity.	9481	9481	9481	9481	9481	9481	8891
AC Line Filter* – Provides Class A RFI (EMI) suppression. Installs onto the drive’s PC board with quick-connect terminals. “S” Suffix: Filter is used when On/Off AC Line Switch is installed. “NS” Suffix: Filter is used when On/Off AC Line Switch is not installed.	“S” Suffix	9507	9512	9479	—	9479	9516
	“NS” Suffix	9507	9512	9515	—	9515	
Liquidtight Fittings – Provide a liquidtight seal for wiring the drive. Kit includes three 1/2” and one 3/4” liquidtight fittings for case A and case B drives, and one 1/2” and two 3/4” liquidtight fittings for case C drives.	9526	9526	9526	9526	9526	9526	8892

* Complies with CE Council Directive 89/336/EEC Industrial Standard.



***Warning!** It is highly recommended that the SIAC-PS Signal Isolator with Power Supply be installed when using the drive with external control signals. See Appendix A, on Page 33, for more information.

Figure 2 – KBAC-24D Control Layout

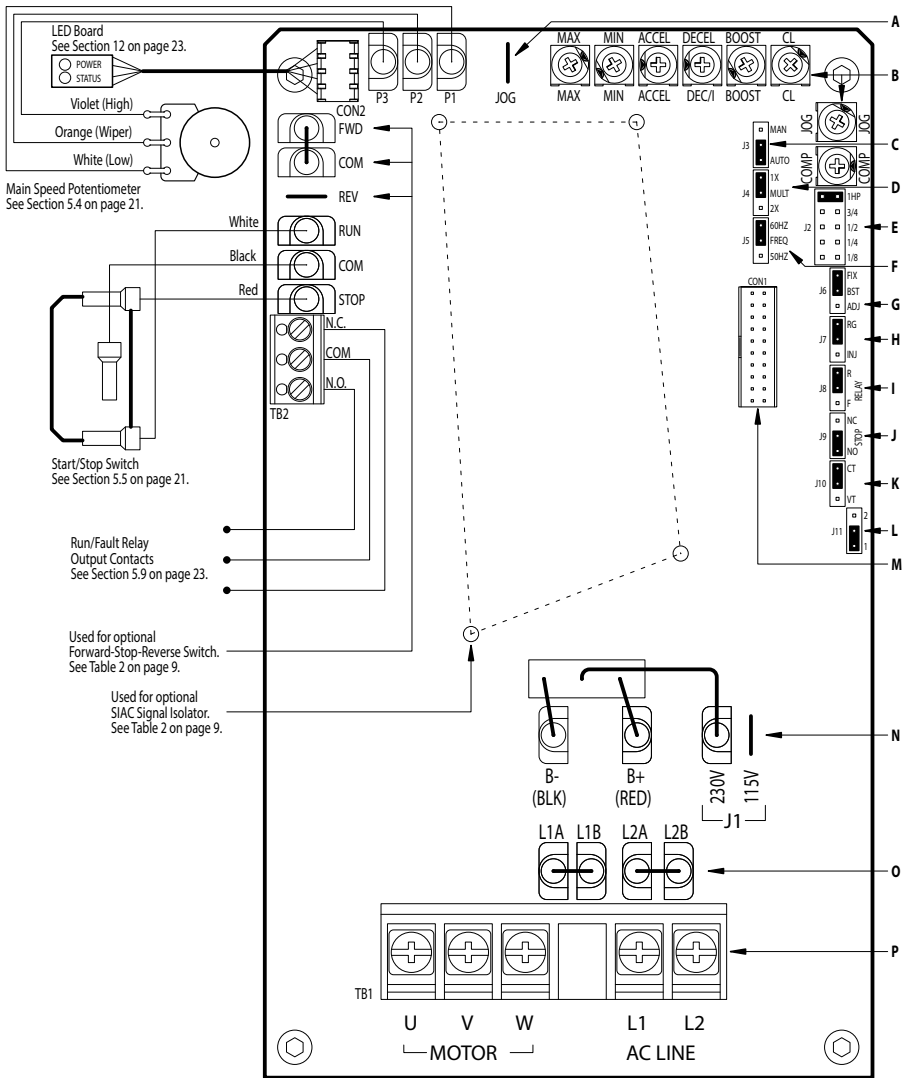

All jumpers and trim pots are shown in factory set positions.

- A** – JOG Terminal. Used with optional Run/Jog Switch Kit. See Table 2 on page 9.
- B** – Adjustable trim pots. See Section 13 on Pages 29 - 32.
- C** – J3: Automatic Ride-Through or Manual Restart selection. See Section 6.3 on page 23.
- E** – J2: Motor Horsepower selection. See Section 6.2 on pages 23 and 24.
- D** – J4: 1X or up to 2X Rated Motor RPM Operation selection. See Section 6.4 on page 24.
- G** – J6: Fixed or Adjustable Boost selection. See Section 6.5 on page 24.
- F** – J5: 60 Hz or 50 Hz Motor Operation selection. See Section 6.4 on page 24.
- H** – J7: Regenerative or Injection Braking selection. See Section 6.6 on page 25.
- I** – J8: Run or Fault Output Relay Operation selection. See Section 6.7 on page 25.
- J** – J9: Normally Open or Closed Stop Contact selection. See Section 6.8 on page 25.
- L** – J11: Not used.
- K** – J10: Constant or Variable Torque selection. See Section 6.9 on page 25.
- M** – CON1: Used to connect optional accessories to the drive. See Table 2 on page 9.
- N** – J1: AC Line Input Voltage selection. (Models KBAC-24D, 27D only) See Section 6.1 on page 23.
- O** – L1A/L1B and L2A/L2B: For optional On/Off AC Line Switch. See Table 2 on page 9.
- P** – TB1: Motor and AC Line input connections. See Sections 5.1 - 5.3 on pages 19 - 21.

Figure 3 – KBAC-27D*, 29, 29 (1P), 45, 48 Control Layout¹

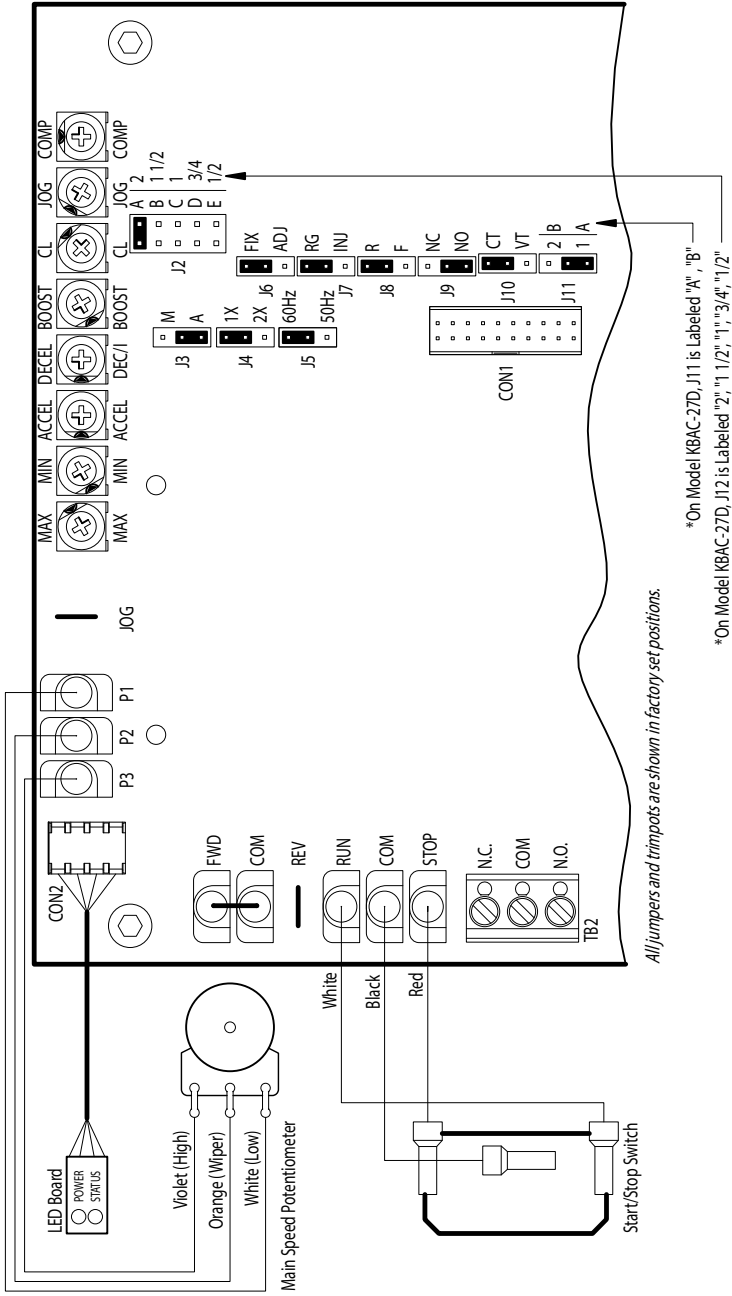
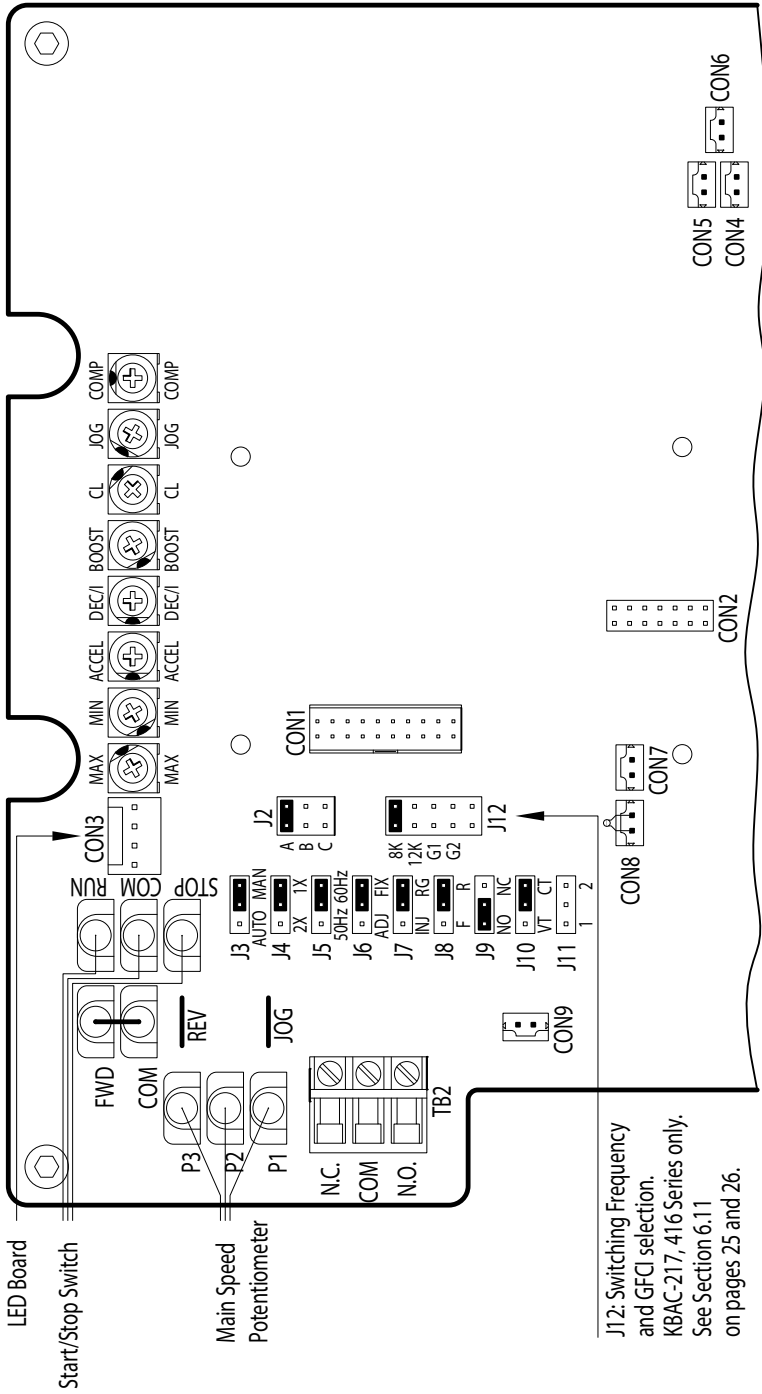

Figure 4 – KBAC-217, 416 Series Control Layout



All jumpers and trim pots are shown in factory set positions.

Table 3 – General Performance Specifications

Description	Specification	Factory Setting
115 Volt AC Line Input Voltage Operating Range (Volts AC)	115 ($\pm 15\%$)	—
208/230 Volt AC Line Input Voltage Operating Range (Volts AC)	208 (-15%) / 230 ($+15\%$)	—
400/460 Volt AC Line Input Voltage Operating Range (Volts AC)	380 (-15%) – 460 ($+15\%$)	—
Maximum Load (% Current Overload for 2 Minutes)	150	—
Switching Frequency (kHz) (Jumper J12) (KBAC-217, 416 Series Only)	8, 12	—
Signal Following Input Voltage Range ¹ (Volts DC)	0 – 5	—
Output Frequency Resolution (Bits, Hz)	10, 0.06	—
Minimum Speed Trimpot (MIN) Range (% Frequency Setting)	0 – 40	0
Maximum Speed Trimpot (MAX) Range (% Frequency Setting)	70 – 110	100
Acceleration Trimpot (ACCEL) and Deceleration Trimpot (DEC/1) Range (Seconds)	0.3 – 20	1.5
Boost Trimpot (BOOST) Range (Volts/Hz)	0 – 30	5
Slip Compensation Trimpot (COMP) Range at Drive Rating (Volts/Hz)	0 – 3	1.5
Current Limit Trimpot (CL) Range (% Full Load)	40 – 200	160
Jog Trimpot (JOG) Range (% Frequency Setting)	0 – 100	35
Motor Frequency Setting (Hz) (Jumper J5)	50, 60	60
Output Frequency Multiplier (1X, 2X) (Jumper J4) ²	1, 2	1
Minimum Operating Frequency at Motor (Hz)	1	—
Speed Range (Ratio)	60:1	—
Speed Regulation (30:1 Speed Range, 0 – Full Load) (% Base Speed) ³	2.5	—
Overload Protector Trip Time for Stalled Motor (Seconds)	6	—
Undervoltage/Overvoltage Trip Points for 115 Volt AC Line Input ($\pm 5\%$) (Volts AC) ⁴	76 – 141	—
Undervoltage/Overvoltage Trip Points for 208/230 Volt AC Line Input ($\pm 5\%$) (Volts AC) ⁴	151 – 282	—
Undervoltage/Overvoltage Trip Points for 400/460 Volt AC Line Input ($\pm 5\%$) (Volts AC) ⁴	302 – 567	—
Run/Fault Relay Output Contact Rating (Amps at 30 Volts DC, 125 Volts AC, 250 Volts AC)	1, 0.5, 0.25	—
Operating Temperature Range ($^{\circ}\text{C}$ / $^{\circ}\text{F}$) ⁵	0 – 40 / 32 – 104	—
Operating Humidity Range (% Relative, Non-Condensing)	0 – 95	—
Storage Temperature Range ($^{\circ}\text{C}$ / $^{\circ}\text{F}$)	-2.5 – +85 / -13 – +185	—

Notes: **1.** Requires an isolated signal. If a non-isolated signal is used, or if using 0 to ± 2.5 thru 0 to ± 25 Volts DC, or 4 – 20 mA DC signal input, install the SIAC-PS Signal Isolator with Power Supply. **2.** Allows the motor to operate up to two times the rated RPM. Constant horsepower will result when operating the drive in the "X2" mode above the motor rated frequency. **3.** Dependent on motor performance. **4.** Do not operate the drive outside the specified AC line input voltage operating range. **5.** See Table 4 on page 14.

Table 4 – Electrical Ratings

Model No.	Part No.		Max. HP		AC Line Voltage (50/60 Hz)	Phase (Ø)	Max. AC Line Current (Amps AC)	Fuse or Circuit Breaker Rating (Amps)	Voltage Range (Volts AC)	Max. Load Current (Amps/Phase)	Motor Horsepower Selection ² (Jumper J2)					Net Wt.	
	Gray	White ¹	HP	kW							lbs	kg					
KBAC-24D	9987	9988	1	0.75	115	1	14.4	20	0-208/230	3.6	1	3/4	1/2	1/4	1/8	5.9	2.7
				208/230	8.1		15										
KBAC-27D	9520	9521	1½	1.13	115	1	22	25	0-208/230	5.5	—	1½ ³	1	3/4	1/2	10.3	4.7
				2	1.5		208/230	16.7									

Model No.	Part No.	Part No.	Phases	Max. HP	AC Line Voltage (50/60 Hz)	Phase (Ø)	Max. AC Line Current (Amps AC)	Fuse or Circuit Breaker Rating (Amps)	Voltage Range (Volts AC)	Max. Load Current (Amps/Phase)	Motor Horsepower Selection ² (Jumper J2)					lbs	kg
											A	B	C	D	E		
KBAC-29 (1P) ⁴	10001	10002	3	2.25	208/230	1	20.5	25	0-208/230	9	3	2	1½	1	3/4	10.3	4.7
KBAC-29	9528	9529	3	1.5	208/230	1	16.7	20	0-208/230	6.7	—	2 ⁵	1½	1	3/4		
				2	2.25	3	11.7	15									
KBAC-45 ⁶	9530	9531	3	2.25	400/460	3	7.2	10	0-400/460	5.5	3	2	1½	1	3/4		
KBAC-48 ⁶	9540	9541	5	3.75	400/460	3	11	15	0-400/460	8.3	5	3	2	1½	1		

Model No.	Part No.	Part No.	Phases	Max. HP	AC Line Voltage (50/60 Hz)	Phase (Ø)	Max. AC Line Current (Amps AC)	Fuse or Circuit Breaker Rating (Amps)	Voltage Range (Volts AC)	Max. Load Current (Amps/Phase)	Motor Horsepower Selection ² (Jumper J2)			lbs	kg
											A	B	C		
KBAC-217	8868	8879	5	3.75	208/230	3	22.1	25	0-208/230	17	5	3	2	22	10
KBAC-217S	8863	8855													
KBAC-217F	8861	8853													
KBAC-217SF	8869	8880													
KBAC-416	8870	8881	10	7.5	400/460	3	20.8	25	0-400/460	16	10	7.5	5	22	10
KBAC-416S	8864	8856													
KBAC-416F	8874	8883													
KBAC-416SF	8871	8882													

Notes: **1.** White FDA approved finish. **2.** Bold indicates factory setting. On Model KBAC-24D, Jumper J2 is labeled "1", "3/4", "1/2", "1/4", "1/8" (factory set to the "1" position). On Model KBAC-27D, Jumper J2 is labeled "2", "1½", "1", "3/4", "1/2" (factory set to the "1½" position). On Models KBAC-29, 45, 48, Jumper J2 is labeled "A", "B", "C", "D", "E" (factory set according to the table). **3.** Model KBAC-27D is rated 1½ HP maximum with 115 Volt AC Line input and 2 HP maximum with 208/230 Volt AC Line input. **4.** Model KBAC-29 (1P) is rated 9 Amps at 35 °C / 95 °F and derated to 8.3 Amps at 40 °C / 104 °F. For ambient temperatures above 40 °C / 104 °F, the drive is derated 2.5% per °C. **5.** Model KBAC-29 is rated 2 HP maximum with single-phase AC Line input and 3 HP maximum with 3-phase AC Line input. **6.** Models KBAC-45, 48, KBAC-217 Series and KBAC-416 Series are rated 0 – 400 Volts AC for 50 Hz motor operation and 0 – 460 Volts AC for 60 Hz motor operation.

Figure 5 – Model KBAC-24D Mechanical Specifications (Inches/mm)

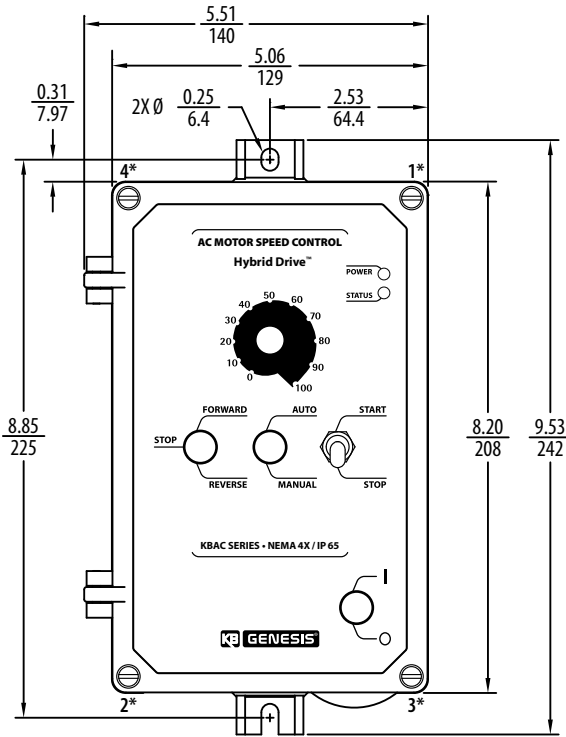

**Tighten these screws, in the sequence shown, to 12 in-lbs (14 kg-cm).*

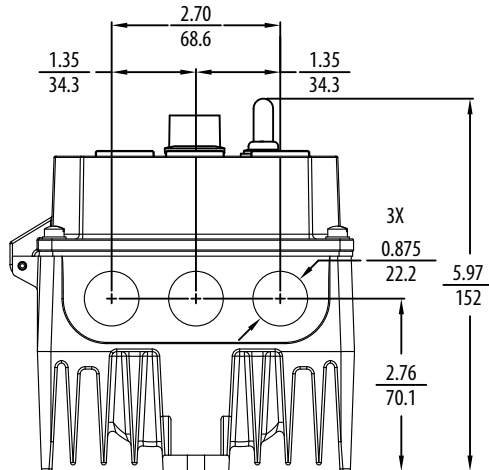
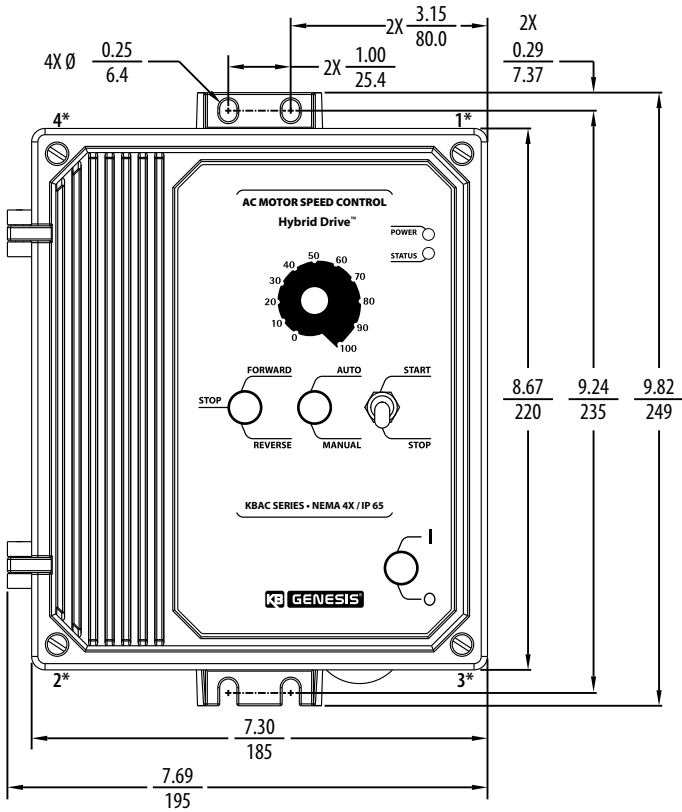

Figure 6 – Models KBAC-27D, 29, 29 (1P), 45, 48 Mechanical Specifications (Inches/mm)



**Tighten these screws, in the sequence shown, to 12 in-lbs (14 kg-cm).*

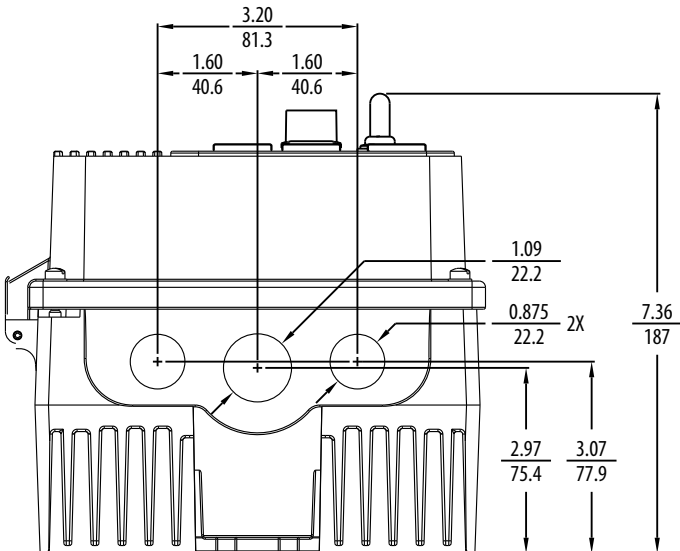
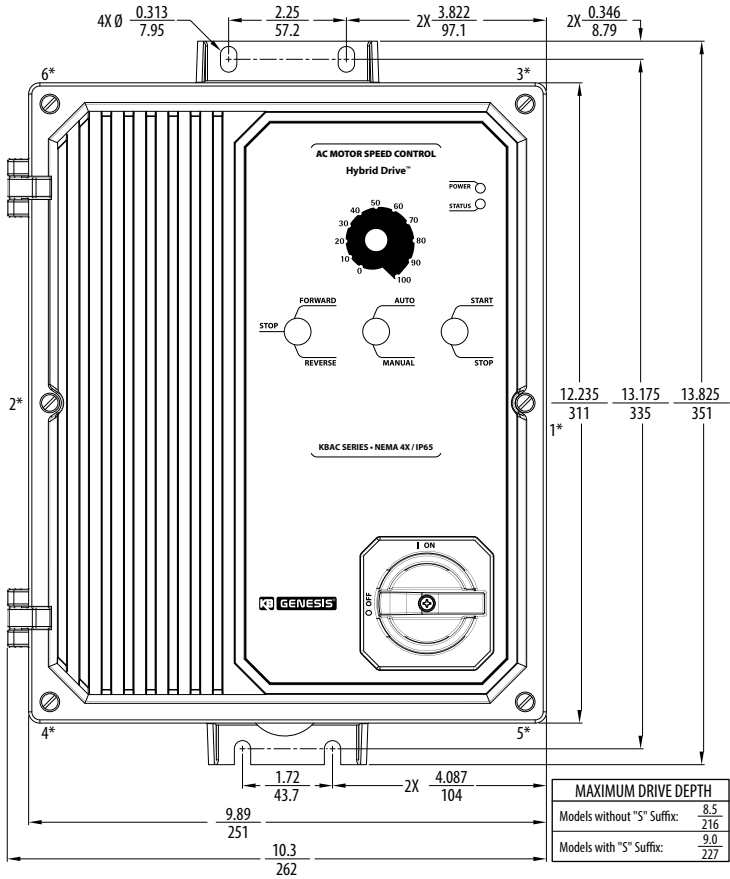
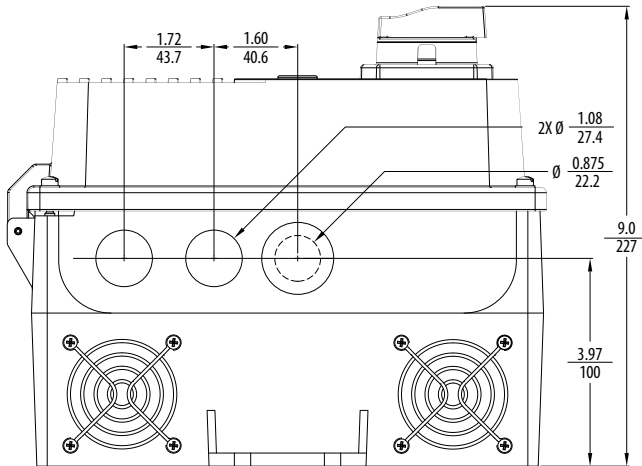

Figure 7 – KBAC-217, 416 Series Mechanical Specifications (Inches/mm)



**Tighten these screws, in the sequence shown, to 12 in-lbs (14 kg-cm).*



4 IMPORTANT APPLICATION INFORMATION

4.1 Motor With External Fan Cooling – Most totally enclosed fan-cooled (TEFC) and open ventilated 3-phase AC induction motors will overheat if used beyond a limited speed range at full torque. Therefore, it is necessary to reduce motor load as speed is decreased.

Note: Some fan-cooled motors can be used over a wider speed range. Consult the motor manufacturer for details.

WARNING! Some motors have low speed characteristics which cause overheating and winding failure under light load or no load conditions. If the motor is operated in this manner for an extended period of time, it is recommended that the unloaded motor current be checked from 2 – 15 Hz (60 – 450 RPM) to ensure motor current does not exceed the nameplate rating. **Do not use motor if the motor current exceeds the nameplate rating.**

It is recommended that the drive be used with Inverter Duty or TENV motors.

Inverter duty and most totally enclosed non-ventilated (TENV) motors can provide full rated torque over an extended speed range without overheating. See Figure 8.

If external fan cooling is provided, open ventilated motors can also achieve an extended speed range at full rated torque. A box fan or blower with a minimum of 100 CFM per HP is recommended. Mount the fan or blower so the motor is surrounded by the airflow. See Figure 9.

4.2 Electronic Motor Overload Protection

– The drive contains Modified I²t Overload Protection.* Part of this function consists of a Current Limit (CL) circuit, which limits the drive current to a factory preset level of 160% of the rated drive current. The CL Trimpot is used to recalibrate the drive current from 60% thru 200%. The Power Start™ circuit provides an overshoot function that allows most motors to develop more than 200% of starting torque and breakdown torque.

Standard I²t is undesirable because it causes nuisance tripping. It allows a very high motor current to develop and will turn the drive off after a short period of time. KB's RMS Current Limit Circuit avoids this nuisance tripping while providing maximum motor protection.

If the motor is overloaded to 120% of full load (75% of the CL setting), the I²t Timer starts. If the motor continues to be overloaded at the 120% level, the timer will shut down the drive after 30 minutes. If the motor is overloaded to 160% of full load, the drive will trip in 6 seconds.

*UL approved as an overload protector for motors.

Figure 8 – Maximum Allowed Motor Torque vs. Speed

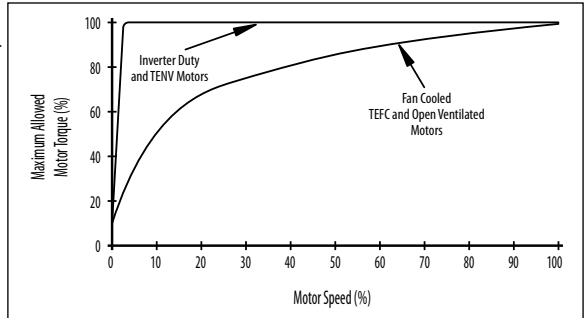
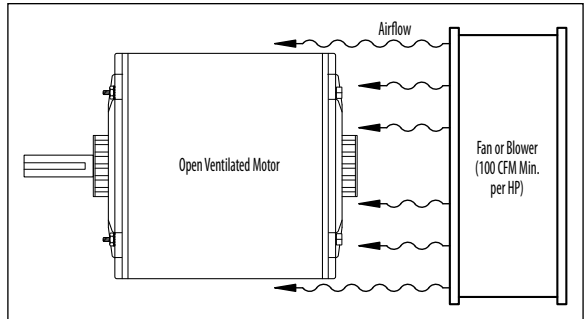

Figure 9 – Open Ventiladed Motor with External Fan Cooling



5 WIRING INSTRUCTIONS



WARNING! Read Safety Warning, on page 6, before using the drive. Disconnect main power before making connections to the drive. To avoid electric shock, be sure to properly ground the drive. It is highly recommended that the SIAC-PS Signal Isolator with Power Supply (Part No. 9600C) be installed when using signal following.



WARNING! HIGH VOLTAGE – REMOTE CONNECTIONS OF POTENTIOMETER, SWITCHES, ETC., WILL HAVE WIRING THAT IS AT LINE POTENTIAL. IT IS REQUIRED THAT THE SIGNAL ISOLATOR BE INSTALLED FOR REMOTE CONNECTIONS.

Application Note – To avoid erratic operation, do not bundle the AC Line and motor wires with each other or with wires from signal following, start/stop contacts, or any other signal wires. Also, do not bundle motor wires from multiple drives in the same conduit. Use shielded cables on all signal wiring over 12" (30 cm). The shield should be earth grounded on the drive side only. Wire the drive in accordance with the National Electrical Code requirements and other local codes that may apply.

Be sure to properly fuse each AC Line conductor that is not at ground potential. Do not fuse neutral or grounded conductors. A separate AC Line switch or contactor must be wired as a disconnect so that each ungrounded conductor is opened. For fuse or circuit breaker selection, see Table 5. Also see Section 11 on page 28.

To maintain the watertight integrity of the drive, be sure to use suitable liquidtight fittings and wiring which are appropriate for the application. Model KBAC-24D contains three holes for standard 1/2" liquidtight fittings (not supplied) (one 1/2" watertight hole plug is provided). Models KBAC-27D, 29, 29 (1P), 45, 48 contain two holes for standard 1/2" liquidtight fittings (not supplied) and one hole for standard 3/4" liquidtight fitting (not supplied) (one 1/2" watertight hole plug is provided). The KBAC-217, 416 Series contain one hole for standard 1/2" liquidtight fittings (not supplied) and two holes for standard 3/4" liquidtight fittings (not supplied) (one 1/2" watertight hole plug is provided).

The drive is designed with a hinged case so that when the front cover is open, all wiring stays intact. To open the cover, the four screws must be loosened so they are no longer engaged in the case bottom. After mounting and wiring, close the cover making sure that the wires do not get caught or crimped as the cover is closed. Tighten the four screws so that the gasket is slightly compressed. The recommended tightening torque is 12 in-lbs (14 kg-cm). See Figures 5, 6 and 7 on pages 15-17 for the tightening sequence. Do not overtighten.

Table 5 – Terminal Block Wiring Information

Terminal Block	Description	Model	Maximum Wire Size (Cu)		Recommended Tightening Torque	
			AWG	mm ²	in-lbs	kg-cm
TB1	AC Line Input and Motor Wiring	KBAC-24D	12	3.3	7	8
		KBAC-27D, 29, 29 (1P), 45, 48	12	3.3	12	14
TB2	Run/Fault Relay Output Contacts	KBAC-24D, 27D, 29, 29 (1P), 45, 48	14	2.08	3.5	4
		KBAC-217, 416 Series	12	3.3	4.4	5

5.1 AC Line Input Connection – Wire the AC Line input to Terminal Block TB1.

GFCI Operation: Models KBAC-24D, 27, 29, 29 (1P), 45, 48 require custom software – contact our Sales Department. The KBAC-217, 416 Series are jumper selectable (J12) for Standard (G1) or Sensitive (G2) GFCIs.

Note: The rated AC Line voltage of the drive must match the actual AC Line input voltage. On Models KBAC-24D, 27D, the setting of Jumper J1 must match the AC Line input voltage.

Models KBAC-24D, 27D: Designed to accept 1-phase AC Line input only (Terminals L1, L2). Rated for 208/230 Volt AC Line input with Jumper J1 set to the "230V" position (factory setting). Rated for 115 Volt AC Line input with Jumper J1 set to the "115V" position. See Figure 10.

Model KBAC-29: Designed to accept 1-phase (Terminals L1, L2) or 3-phase (Terminals L1, L2, L3) AC Line input. Rated for 208/230 Volt AC Line input only. See Figure 11.

Model KBAC-29(1P): Designed to accept 1-phase AC Line input (Terminals L1, L2). Rated for 208/230 Volt AC Line input only. See Figure 10.

Figure 10 – Models KBAC- 24D, 27D*, 29 (1P) AC Line Input, Motor, and Ground Connections

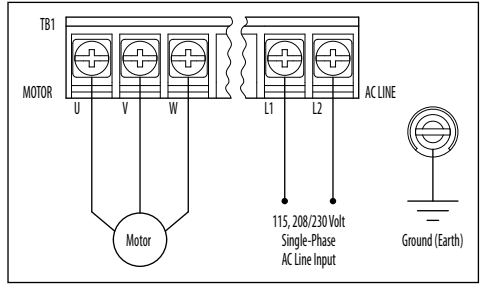

*Model KBAC-27D is rated 1½ HP maximum with 115 Volt AC Line input and 2 HP maximum with 208/230 Volt AC Line input.

Figure 11 – Models KBAC-29*, 45, 48 AC Line Input, Motor, and Ground Connections

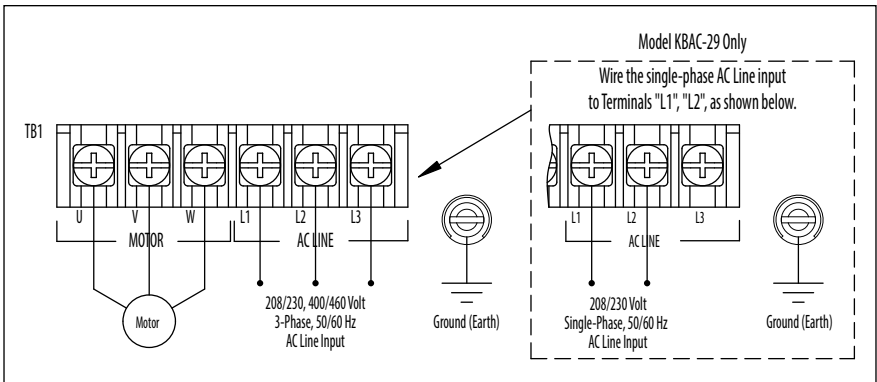

*Note: Model KBAC-29 is rated 2 HP maximum with 1-phase AC Line input and 3 HP maximum with 3-phase AC Line input.

Models KBAC-45, 48: Designed to accept 3-phase AC Line input only (Terminals L1, L2, L3). Rated for 400/460 Volt AC Line input only. See Figure 11.

KBAC-217 Series: Designed to accept 3-phase (Terminals L1, L2, L3) AC Line input. Rated for 208/230 Volt AC Line input only. See Figure 12.

KBAC-416 Series: Designed to accept 3-phase (Terminals L1, L2, L3) AC Line input. Rated for 400/460 Volt AC Line input only. See Figure 12.

Figure 12 – KBAC-217, 416 Series AC Line Input, Motor, and Ground Connections

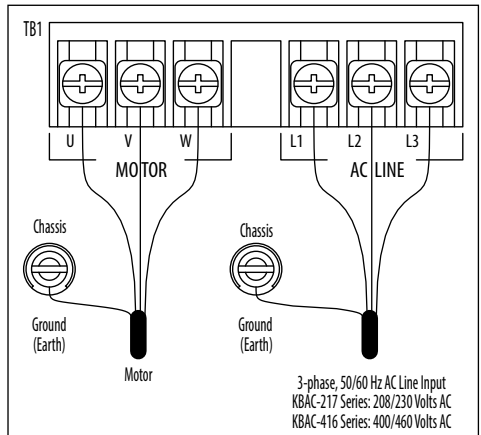

- 5.2 Ground Connection** – Connect the Ground Wire (Earth) to the Green Ground Screw. The Ground Screw is located next to Terminal Block TB1. See Figures 10 -12.

- 5.3 Motor Connection** – Wire the motor to Terminal Block TB1 Terminals U, V, W. See Figures 10-12 on page 20. Motor cable length should not exceed 100 ft (30 m) – special reactors may be required – consult our Sales Department.

Be sure Jumper J2 is set to the corresponding motor horsepower rating, as described in Section 6.2 on page 23.

- 5.4 Remote Main Speed Potentiometer Connection** – The drive is supplied with a prewired Main Speed Potentiometer mounted on the front cover.

To operate the drive from a remote potentiometer (5 kΩ), remove the white, orange, and violet potentiometer leads from Terminals P1, P2, and P3. The wires may be taped and left inside the drive. The potentiometer assembly may be removed if a watertight seal is used to cover the hole in the front cover. Wire the Main Speed Potentiometer to Terminals P1 (low side), P2 (wiper), and P3 (high side). See Figure 13.

WARNING! Do not earth ground any Main Speed Potentiometer terminals.

Application Note – If it is required that the Remote Main Speed Potentiometer be isolated from the AC Line, install the SIAC-PS Signal Isolator with Power Supply (See Table 2 on page 9).

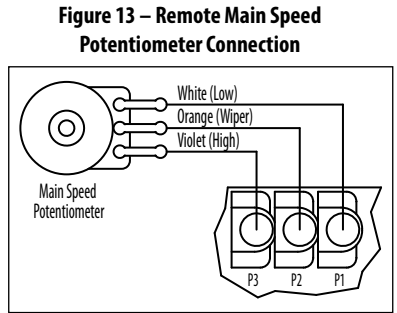

HIGH VOLTAGE! See Warning on Page 19.

Figure 14 – Remote Start/Stop Switch Connection with Normally Open Stop Contact (J9 Installed in “NO” Position)

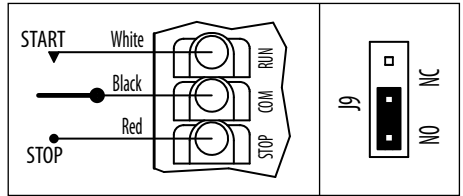

HIGH VOLTAGE! See Warning on Page 19.

- 5.5 Remote Start/Stop Switch Connection** –

The drive is supplied with a prewired Start/Stop Switch mounted on the front cover to electronically start and stop the drive.

To operate the drive from a remote Start/Stop Switch (type (ON)-OFF-ON, SPDT), remove the white, black, and red wires from Terminals RUN, COM, and STOP. The wires may be taped and left inside the drive. The switch assembly may be removed if a liquidtight seal is used to cover the hole in the front cover. After applying power to the drive, momentarily set the Start/Stop Switch to the “START” position.

Figure 15 – Remote Start/Stop Switch Connection with Normally Closed Stop Contact (J9 Installed in “NC” Position)

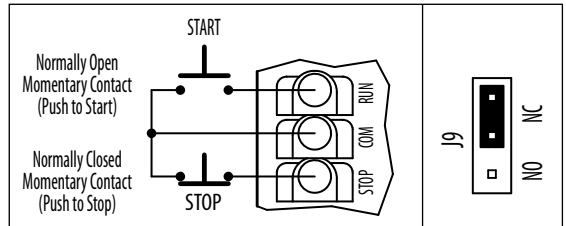

HIGH VOLTAGE! See Warning on Page 19.

For Start/Stop Switch with normally closed stop contact, set Jumper J9 to the “NC” position. See Figures 14 and 15. Also see Section 6.8 on page 25.

- 5.6 Automatic Restart** – Automatic restart requires the elimination of the Start/Stop Switch. Remove the white, black, and red wires from Terminals RUN, COM, and STOP. The wires may be taped and left inside the drive. The switch assembly may be removed if a liquidtight seal is used to cover the hole in the front cover.

To eliminate the Start/Stop function, hardwire Terminals RUN and COM with the jumper that is provided. Be sure Jumper J9 is set to the “NO” position. See Figure 16.

WARNING! Using a jumper to eliminate the Start/Stop function will cause the motor to run at the Main Speed Potentiometer setting when the AC Line is applied.

Figure 16 – Start/Stop Function Eliminated (Terminals Hardwired) (Jumper Installed) (J9 Installed in “NO” Position)

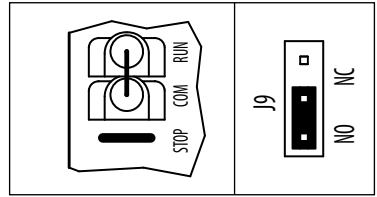

HIGH VOLTAGE!
See Warning on Page 19.

- 5.7 Voltage Following Connection** – An isolated* 0 – 5 Volt DC analog signal input can also be used to control motor speed in lieu of the Main Speed Potentiometer. The drive output will linearly follow the analog signal input. Wire the signal input positive lead (+) to Terminal P2 and the negative lead (-) to Terminal P1. With external circuitry, a 0 – 10 Volt DC analog signal can also be used. See Figure 17.

**If a non-isolated signal is used, install the SIAC-PS Signal Isolator with Power Supply. The SIAC-PS accepts voltage (0 to ± 2.5 thru 0 to ± 25 Volts DC) or current (4 – 20 mA DC) signal inputs. See Table 2 on page 9. See Appendix A on page 33 for SIAC-PS information.*

Figure 17 – Voltage Following Connections (Isolated)

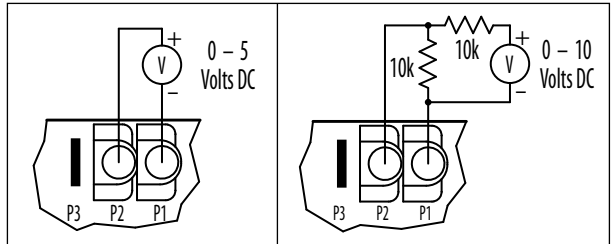

HIGH VOLTAGE! See Warning on Page 19.

Note: For signal following operation, the Minimum Speed Trimpot (MIN) must be set fully counterclockwise.

WARNING! The signal input must be isolated from the AC Line. Earth grounding signal wiring will damage the drive and void the warranty. It is highly recommended that the SIAC-PS Signal Isolator with Power Supply be installed when using signal following.

Figure 18 – Enable Circuit Connection

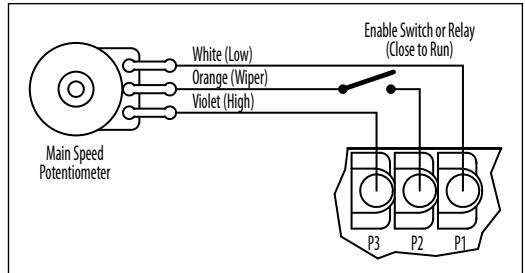

HIGH VOLTAGE! See Warning on Page 19.

- 5.8 Enable Circuit Connection** – The drive can also be started and stopped with an Enable circuit (close to run, open to stop). See Figure 18.

The Enable function is established by wiring a switch or contact in series with the orange Main Speed Potentiometer lead which connects to Terminal P2. When the Enable Switch is closed, the motor will accelerate to the Main Speed Potentiometer setting. When the Enable Switch is opened, the motor will decelerate to stop.

WARNING! If the Enable Switch is to be mounted remotely, it is highly recommended that the SIAC-PS Signal Isolator with Power Supply be installed.

Table 6 – Drive Operating Condition and Run/Fault Relay Contact Status

Drive Operating Condition	Description	Run Relay Operation (Jumper J8 Installed in "R" Position) (Factory Setting)		Fault Relay Operation (Jumper J8 Installed in "F" Position)	
		Normally Open Contact	Normally Closed Contact	Normally Open Contact	Normally Closed Contact
Power Off	Main Power Disconnected	Open	Closed	Open	Closed
Run Mode*	Normal Drive Operation	Closed	Open	Closed	Open
Stop Mode*	Selected by Operator	Open	Closed	Closed	Open
Fault**	Drive Tripped	Open	Closed	Open	Closed

*Run Mode or Stop Mode is selected using the Start/Stop Switch. **Overload, Ft, Short Circuit, Undervoltage and Overvoltage.

5.9 Run/Fault Relay Connection – The Run/Fault Relay Output Contacts are located at TB2 and can be used to turn equipment on or off, to signal a warning if the drive is put into the Stop Mode, or a fault has occurred. See Figure 19.

The Run/Fault Relay Contact status for various drive operating conditions is shown in Table 6.

Figure 19 – Run/Fault Relay Output Contacts Connection

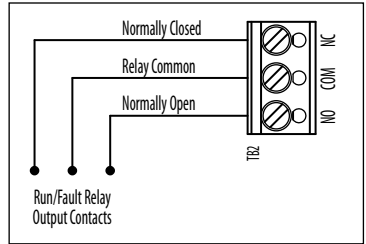

6 SETTING SELECTABLE JUMPERS

The drive has customer selectable jumpers which must be set before the drive can be used.



WARNING! HIGH VOLTAGE Disconnect the AC Line before changing position of jumpers.



HIGH VOLTAGE! See Warning on Page 14.

6.1 Line Input Voltage Selection (J1) (Models KBAC-24D, 27D Only) –

Jumper J1 is factory installed on Terminal "230V" for 208/230 Volt AC Line input. For 115 Volt AC Line input, the jumper must be removed and installed on Terminal "115V". See Figure 20.

Using pliers, gently rock the female terminal back and forth while pulling it upward. See Figure 21.

Figure 20 – Models KBAC-24D*, 27D AC Line Input Voltage Selection

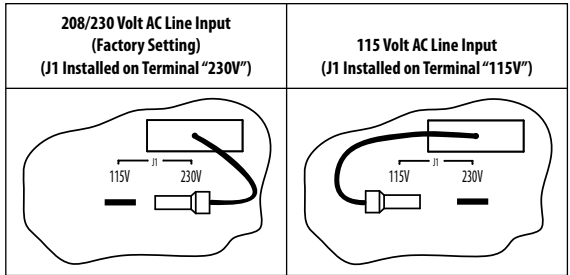

*Layout of Model KBAC-24D varies slightly.

6.2 Motor Horsepower Selection (J2) – Set Jumper J2 to the corresponding position for the motor being used. See Figure 22 on page 24.

Figure 21 – Removing Jumper J1 on Models KBAC-24D, 27D

6.3 Automatic Ride-Through or Manual Start Selection (J3)* Jumper J3 is factory set to the "A" position for Automatic Ride-Through. If the power is interrupted for up to 2 seconds, the drive will shut down and then "ride-through" and automatically return to the set frequency.

If Jumper J3 is set to the "M" position, the drive will have to be manually restarted for a momentary power loss using the Start/Stop Switch. See Figure 23 on page 24. Also see Section 12.2 on page 28, for the Status (ST) LED indication.

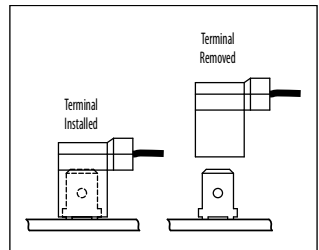

*On Models KBAC-24D, KBAC-217 Series, and KBAC-416 Series, Jumper J3 is labeled "AUTO" and "MAN".

Figure 22 – Motor Horsepower Selection

	KBAC-24D	KBAC-27D		KBAC-29*	KBAC-29 (1P)*	KBAC-45*	KBAC-48*	KBAC-217 Series	KBAC-416 Series
J2 □ □ □ □ □ □ □ □	1	2**	A	3***	3	3	5	5	10
	3/4	1½**	B	2***	2	2	3	3	7.5
	1/2	1	C	1½	1½	1½	2	2	5
	1/4	3/4	D	1	1	1	1½	—	—
	1/8	1/2	E	3/4	3/4	3/4	1	—	—

The factory setting is shown in **bold**.

*Jumper J2 on Models KBAC-29, 45, 48 is labeled "A", "B", "C", "D", "E" and on KBAC-217 Series and KBAC-416 Series is labeled "A", "B", "C". **Model KBAC-27D is rated 1½ HP maximum with 115 Volt AC Line input and 2 HP maximum with 208/230 Volt AC Line input. ***Model KBAC-29 is rated 2 HP maximum with 1-phase AC Line input and 3 HP maximum with 3-phase AC Line input.

6.4 60 Hz and 50 Hz Motor Operation and Drive Output Frequency Selection (J4 and J5) – Both jumpers must be set for the appropriate motor nameplate frequency rating.

6.4.1 Setting the Drive for 60 Hz or 50 Hz Motor Operation – The drive is factory set to operate 60 Hz motors. Jumper J4 is factory set to the "1X" position and Jumper J5 is factory set to the "60Hz" position. For 50 Hz motors, set Jumper J5 to the "50Hz" position, and be sure Jumper J4 is set to the "1X" position. See Figure 24.

6.4.2 Setting the Drive for Two Times the Rated Motor RPM – The drive can also be used to operate the motor up to two times the rated RPM. However, constant horsepower will result when operating the drive in the "2X" mode above the motor rated frequency. See Figure 23.

For 120 Hz output with 60 Hz motor, set Jumper J4 to the "2X" position and be sure Jumper J5 is set to the "60Hz" position.
For 100 Hz output with 50 Hz motor, set Jumper J4 to the "2X" position and set Jumper J5 to the "50Hz" position. See Figure 26 on page 25.

6.5 Boost Mode Selection (J6) – Jumper J6 is factory set to the "FIX" position for Fixed Boost. For Adjustable Boost using the BOOST Trimpot, set Jumper J6 to the "ADJ" position. See Figure 27 on page 25. Also see Section 13.8 on pages 31 and 32 for the BOOST Trimpot range.

Figure 23 – Automatic Ride-Through or Manual Start Selection*

Automatic Ride-Through (Factory Setting) (J3 Installed in "A" Position)	Manual Start (J3 Installed in "M" Position)

*On Model KBAC-24D, Jumper J3 is labeled "AUTO" and "MAN".

Figure 24 – 60 Hz & 50 Hz Motor Selection

60 Hz Motor Operation (Factory Setting) (J4 Installed in "1X" Position) (J5 Installed in "60Hz" Position)	50 Hz Motor Operation (J4 Installed in "1X" Position) (J5 Installed in "50Hz" Position)

Figure 25 – Available Torque vs. Output Frequency

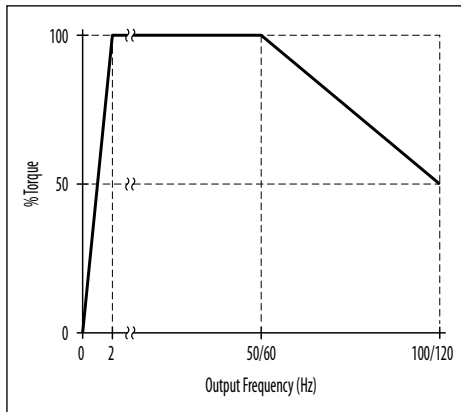

6.6 Braking Mode Selection (J7) – Jumper J7 is factory set to the “RG” position for Regenerative Braking when the Start/Stop Switch is set to the “STOP” position. For DC Injection Braking, set Jumper J7 to the “INJ” position. See Figure 28. Also see Section 13.5 on page 29.

When the Injection Brake Mode is selected, the DEC/I Trimpot is used to adjust the brake time and intensity.

6.7 Run/Fault Output Relay Operation Selection (J8) – Jumper J8 is factory set to the “R” position for “Run” operation of the Run/Fault Relay. For “Fault” operation of the Run/Fault Relay, set Jumper J8 to the “F” position. See Figure 29.

For Run/Fault Relay output contacts, see Section 5.8 on page 22. The Run/Fault Relay contact status for various drive operating conditions is shown in Table 6 on page 23.

6.8 Stop Contact Selection (J9) – Jumper J9 is factory set to the “NO” position for a normally open stop contact. For remote normally closed stop contact, set Jumper J9 to the “NC” position. See Figure 30. For wiring information, see Section 5.5 on page 21.

6.9 Torque Mode Selection (J10) – Jumper J10 is factory set to the “CT” position for Constant Torque Mode, which is desirable for most machine applications. For Variable Torque Mode, used for HVAC and fan applications, set Jumper J10 to the “VT” position. See Figure 31.

6.10 Jumper J11 – Not used.

6.11 Switching Frequency and GFCI (J12) (KBAC-217, 416 Series only) – Jumper J12 is set to the “8K” position for a switching frequency at the motor of 8 kHz. For 12 kHz switching frequency, set jumper J12 to the “12K” position. This jumper also allows the drive to be used on standard (“G1” position) or sensitive (“G2” position) GFCIs. **Note:** GFCI operation may increase audible noise.

Figure 30 – Normally Open or Closed Stop Contact Selection

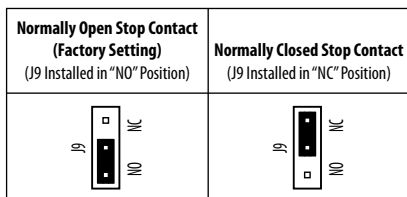

**Figure 26
120 Hz & 100 Hz Drive Output Frequency Selection**

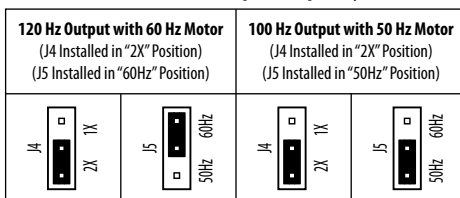

Figure 27 – Fixed or Adjustable Boost Selection

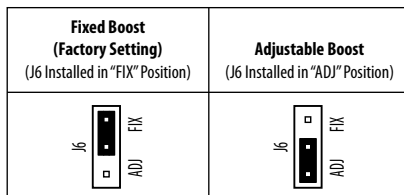

Figure 28 – Regenerative or DC Injection Braking Selection

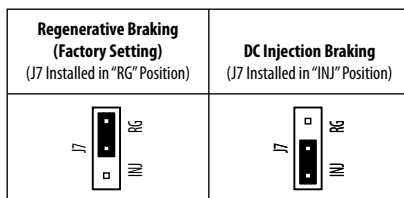

Figure 29 – “Run” or “Fault” Output Relay Operation Selection

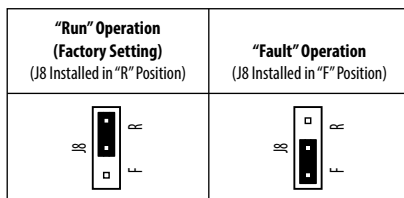
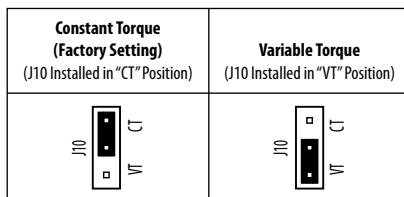

Figure 31 – Constant or Variable Torque Selection



**Figure 32 – Switching Frequency and GFCI Selection
(KBAC-217, 416 Series only)**

J12		
8K	<input checked="" type="checkbox"/> <input checked="" type="checkbox"/>	8 kHz (Factory Setting)
12K	<input type="checkbox"/> <input type="checkbox"/>	12 kHz
G1	<input type="checkbox"/> <input type="checkbox"/>	Standard GFCI
G2	<input type="checkbox"/> <input type="checkbox"/>	Sensitive GFCI
	<input type="checkbox"/> <input type="checkbox"/>	Not Used

7 MOUNTING INSTRUCTIONS

It is recommended that the drive be mounted vertically on a flat surface with adequate ventilation. Leave enough room below the drive to allow for AC Line, motor connections, and any other wiring that is required. Although the drive is designed for outdoor and washdown use, care should be taken to avoid extreme hazardous locations where physical damage can occur. When mounting the drive in an enclosure, the enclosure should be large enough to allow for proper heat dissipation so that the ambient temperature does not exceed 40 °C (104 °F) at full rating. See Figures 5 -7 on pages 15-17.



WARNING! Do not use this drive in an explosion-proof application.

8 RECOMMENDED HIGH VOLTAGE DIELECTRIC WITHSTAND TESTING (HI-POT TESTING)

Testing agencies such as UL, CSA, VDE, etc., usually require that equipment undergo a hi-pot test. In order to prevent catastrophic damage to the drive which has been installed in the equipment, the following procedure is recommended. A typical hi-pot test setup is shown in Figure 33 on page 27. All drives have been factory hi-pot tested in accordance with UL requirements.



WARNING! All equipment AC Line inputs must be disconnected from the AC power.

- 8.1 Connect all equipment AC power input lines together and connect them to the H.V. lead of the hi-pot tester. Connect the RETURN lead of the hi-pot tester to the frame on which the drive and other auxiliary equipment are mounted.
- 8.2 The hi-pot tester must have an automatic ramp-up to the test voltage and an automatic ramp-down to zero voltage.

Note: *If the hi-pot tester does not have automatic ramping, then the hi-pot output must be manually increased to the test voltage and then manually reduced to zero. This procedure must be followed for each machine to be tested. A suggested hi-pot tester is Slaughter Model 2550.*

CAUTION! Instantly applying the hi-pot voltage will cause irreversible damage to the drive, which will void the warranty.

9 RECONDITIONING THE BUS CAPACITORS

If this drive has been in storage for over one year it is necessary to recondition the power supply bus capacitors. To recondition the bus capacitors, apply the AC Line, with the drive in the Stop Mode, for a minimum of one hour. Not following this procedure will cause the bus capacitors to fail.

Figure 33 – Typical HI-Pot Test Setup

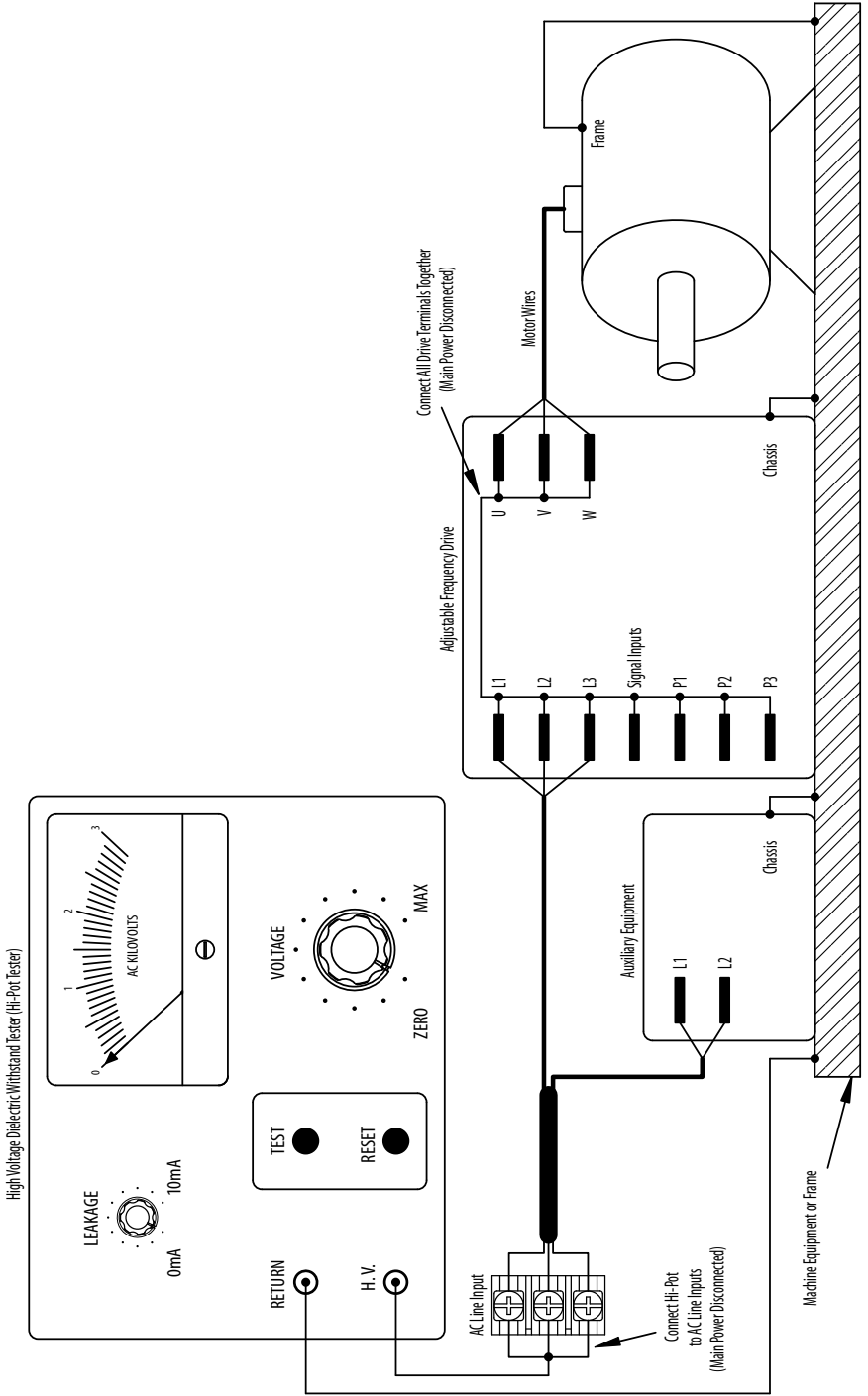

10 DRIVE OPERATION

10.1 Start-Up Procedure – After the drive has been properly setup (jumpers and trimpots set to the desired positions) and wiring completed, the start-up procedure can begin. If the AC power has been properly brought to the drive, the power (PWR) LED will illuminate green. The status (ST) LED will indicate drive status, as described in Section 12.2.

To start the drive, momentarily set the Start/Stop Switch to the “START” position. The motor will begin to accelerate to the set speed.



WARNING! Using a jumper to eliminate the start/stop function will cause the motor to run at the Main Speed Potentiometer setting when the AC Line is applied. See Section 10.2.

Note: If the motor rotates in the incorrect direction, it will be necessary to disconnect the AC Line, reverse any two motor leads, and repeat the start-up procedure.

10.2 Restarting the Drive After a Fault has been Cleared^{1,2} – The drive monitors five faults: Undervoltage, Overvoltage, Short Circuit at the motor (phase-to-phase), Overload and Phase Loss Detection. See Section 12.2 for the Status (ST) LED indication. Also see Section 6.3 on page 23 for Automatic Ride-Through or Manual Restart selection with Jumper J3.

To restart the drive after a fault has been cleared, use the Start/Stop Switch^{2,3}.

If the Start/Stop Switch has been eliminated (bypassed), see Section 5.6 on page 21.⁴ The drive can be restarted (after the fault has been cleared) by disconnecting the AC power, and all LEDs are no longer illuminated, and then reconnecting the AC power.

Notes: **1.** For an Overload Fault, be sure the fault has been cleared before restarting the drive. Check the motor current with an AC RMS responding ammeter. Also, the CL setting may be set too low. See Section 13.7 on page 30. **2.** For an Overvoltage Fault, if the drive is set for Automatic Ride-Through, the drive will automatically restart when the AC Line voltage returns to below the specified Overvoltage Trip Point. **3.** If the Forward-Stop-Reverse Switch has been installed, it can be used to restart the drive. **4.** If the Start/Stop Switch has been eliminated (bypassed), the AC Line must be used to restart the drive after an Overload Fault has been cleared.

11 AC LINE FUSING

The drive does not contain line fuses. Most electrical codes require that each ungrounded conductor contain circuit protection. **Do not fuse neutral or ground connections.** It is recommended to install a fuse (Littelfuse 312/314, Buss ABC, or equivalent) or a circuit breaker in series with each ungrounded conductor. **Do not fuse motor leads.** For the recommended fuse size, see Table 4 on page 14.

Wire the drive in accordance with the National Electrical Code requirements and other local codes that may apply to the application.

12 DIAGNOSTIC LEDs

The drive contains two diagnostic LEDs mounted on the enclosure cover to display the drive's operational status.

12.1 Power On LED (PWR) – The “PWR” LED will illuminate green when the AC Line is applied to the drive.



WARNING! Do not depend on the PWR LED as a guaranteed power off condition. Be sure the main power switch or circuit breaker is in the “OFF” position before servicing this drive.

12.2 Status LED (ST) – The “ST” LED is a tricolor LED which provides indication of a fault or abnormal condition. The information provided can be used to diagnose an installation problem such as incorrect input voltage, overload condition, and drive output miswiring. It also provides a signal which informs the user that all drive and microcontroller operating parameters are normal. Table 7, summarizes the “ST” LED functions.

Table 7 – Drive Operating Condition and Status LED Indicator

Drive Operating Condition	Flash Rate ¹ and LED Color
Normal Operation	Slow Flash Green
Overload (120% – 160% Full Load)	Steady Red ²
I ^t (Drive Timed Out)	Quick Flash Red ²
Short Circuit	Slow Flash Red
Undervoltage	Quick Flash Red / Yellow ³
Overvoltage	Slow Flash Red / Yellow ³
Stop	Steady Yellow
Stand-By ⁴	Slow Flash Yellow
Input Phase Loss ⁵	Rapid Flash Yellow
Overtemperature Trip ⁶	Slow / Quick Flash Red ¹

Notes: 1. Slow Flash = 1 second on and 1 second off. Quick Flash = 0.25 second on and 0.25 second off. 2. When the Overload is removed, before the I^t times out and trips the drive, the “ST” LED will flash green. 3. When the Undervoltage or Overvoltage condition is corrected, the “ST” LED will flash Red / Yellow / Green. 4. Only if the Forward-Stop-Reverse Switch is installed. 5. Model KBAC-29, with three-Phase AC Line input, and Models KBAC-45, 48. Rapid Flash = 4 mSec on and 6 mSec off. 6. KBAC-217 Series and KBAC-416 Series only.

13 TRIMPOT ADJUSTMENTS

The drive contains trimpots which are factory set for most applications. See Figure 2 on page 10 for the location of the trimpots and their approximate factory calibrated positions. Some applications may require readjustment of the trimpots in order to tailor the drive for a specific requirement. The trimpots may be readjusted as described below.



WARNING! If possible, do not adjust trimpots with the main power applied. If adjustments are made with the main power applied, an insulated adjustment tool must be used and safety glasses must be worn. High voltage exists in this drive. Fire and/or electrocution can result if caution is not exercised. The Safety Warning on page 5 must be read and understood before proceeding.

- 13.1 Minimum Speed (MIN)** – Sets the minimum speed of the motor. The MIN Trimpot is factory set to 0% of frequency setting. For a higher minimum speed setting, rotate the MIN Trimpot clockwise. See Figure 34 on page 30.
- 13.2 Maximum Speed (MAX)** – Sets the maximum speed of the motor. The MAX Trimpot is factory set to 100% of frequency setting. For a lower maximum speed setting, rotate the MAX Trimpot counterclockwise. For a higher maximum speed setting, rotate the MAX Trimpot clockwise. See Figure 35 on page 30.
- 13.3 Acceleration (ACCEL)** – Sets the amount of time for the motor to accelerate from zero speed to full speed. The ACCEL Trimpot is factory set to 1.5 seconds. For a longer acceleration time, rotate the ACCEL Trimpot clockwise. For more rapid acceleration, rotate the ACCEL Trimpot counterclockwise. See Figure 36 on page 30.

Note: Rapid acceleration settings may cause the current limit circuit to activate, which will extend the acceleration time.

- 13.4 Deceleration (DEC/I)** – Sets the amount of time for the motor to decelerate from full speed to zero speed. The DEC/I Trimpot is factory set to 1.5 seconds. For longer deceleration time, rotate the DEC/I Trimpot clockwise. For more rapid deceleration, rotate the DEC/I Trimpot counterclockwise. See Figure 37 on page 30.

Application Note – On applications with high inertial loads, the deceleration time may automatically increase. This will slow down the decrease speed to prevent the bus voltage from rising to the Overvoltage Trip point. This function is called Regeneration Protection. **It is recommended that for very high inertial loads that both the ACCEL and DEC/I Trimpots be set to greater than 10 seconds.**

- 13.5 DC Injection Brake (DEC/I)** – The drive is factory set for Regenerative Braking (Jumper J7 set to the “RG” position). When the drive is set for DC Injection Brake (Jumper J7 set to the “INJ” position), the DEC/I Trimpot is used to set the DC Injection Brake voltage and time. See Figure 38 on page 30. Also see Section 6.6 on page 25.

The DC Injection Brake voltage and time range is 10% of full drive output voltage for 3 seconds with the trimpot fully clockwise and 25% of full drive output voltage for 1 second with the trimpot fully counterclockwise. Models KBAC-24D, 27D, 29, KBAC-217 Series are factory set for 49 Volts for 1.2 seconds and Models KBAC-45, 48, KBAC-416 Series are factory set for 98 Volts for 1.2 seconds.

Adjust the trimpot so that the load stops within the required time.

Figure 34 – Minimum Speed Trimpot Range

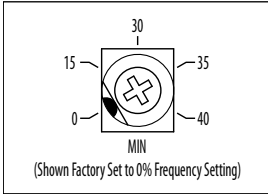

Figure 35 – Maximum Speed Trimpot Range

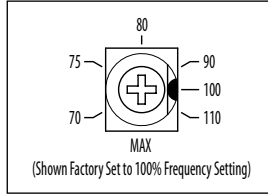

Figure 36 – Acceleration Trimpot Range

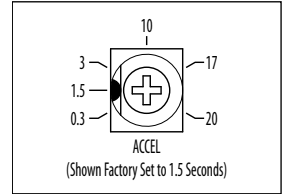

Figure 37 – Deceleration Trimpot Range

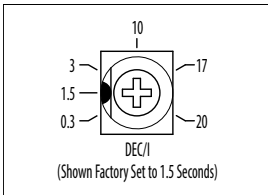
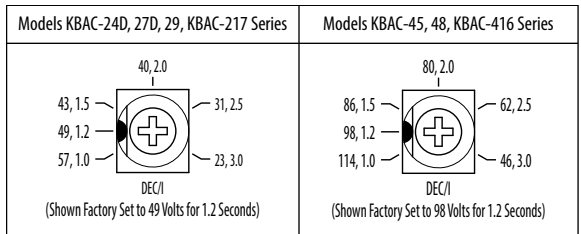

Figure 38 – DC Injection Brake Trimpot Range



13.6 Slip Compensation (COMP) – Sets the amount of Volts/Hz to maintain set motor speed under varying loads. The COMP Trimpot is factory set to 1.5 Volts/Hz, which provides excellent speed regulation for most motors. To increase the slip compensation, rotate the COMP Trimpot clockwise. To decrease the slip compensation, rotate the COMP Trimpot counterclockwise. See Figure 39.

The slip compensation may be adjusted as follows:

1. Wire an AC RMS ammeter in series with one motor phase.
2. Run the motor and set the unloaded speed to approximately 50% (900 RPM on 4-pole 1500/1725 RPM motors).
3. Using a tachometer, record the unloaded speed.
4. Load the motor to the nameplate rated current (AC Amps).
5. Adjust the COMP Trimpot until the loaded RPM is equal to the unloaded RPM.
6. The motor is now compensated to provide constant speed under varying loads.

Figure 39– Slip Compensation Trimpot Range

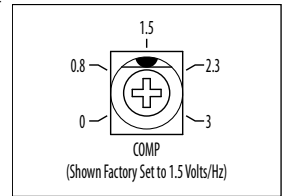
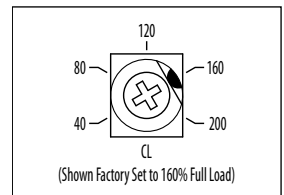

Figure 40 – Current Limit Trimpot Range



13.7 Motor Overload (I²t) With RMS Current Limit (CL)* – Sets the current limit (overload), which limits the maximum current to the motor, which prevents motor burnout and eliminates nuisance trips. The CL Trimpot is factory set to 160% of the drive rated current. To increase the current limit, rotate the CL Trimpot clockwise. To decrease the current limit, rotate the CL Trimpot counterclockwise. See Figure 40. Also see Figure 41 on page 31.

*UL approved as an electronic overload protector for motors.

CAUTION! Adjusting the current limit above 160% of the motor nameplate rating can cause overheating of the motor. Consult the motor manufacturer. Do not leave the motor in a locked rotor condition for more than a few seconds since motor damage may occur.

In order to ensure that the motor is properly protected with the I^t feature, it is required that the CL Trimpot be set for 160% of the motor nameplate rated current, as described below.

Note: This adjustment must be made within 6 seconds or the I^t Trip will occur.

The current limit may be adjusted as follows:

1. Connect an AC RMS ammeter in series with one motor phase.
2. Set the CL Trimpot fully counterclockwise.
3. Adjust the speed setting to 30%.
4. Lock the motor shaft and adjust the CL Trimpot to 160% of the motor nameplate rated current.

Figure 41 – I^t Trip Time vs. Motor Current

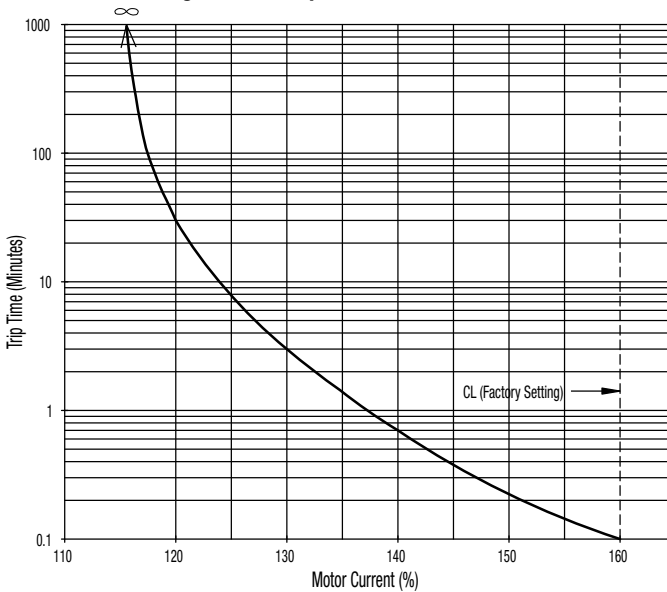

13.8 Boost (BOOST) – The drive is factory set for Fixed Boost (Jumper J6 set to the “FIX” position). When the drive is set for Adjustable Boost (Jumper J6 set to the “ADJ” position), the BOOST Trimpot can be used to adjust the amount of boost voltage to the motor. See Figure 42. Also see Section 6.5 on page 24.

Application Note – The Boost function operates over a frequency range of 0 – 15 Hz. If the frequency range required is above 15 Hz, Boost adjustment is not necessary.

WARNING! To avoid motor winding overheating and failure, do not overboost the motor.

Note: An unloaded motor with excessive boost will draw more current than a partially loaded motor.

Figure 42 – Boost Trimpot Range

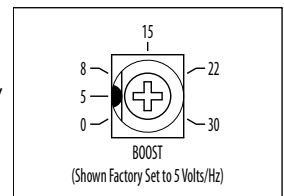

The boost voltage may be adjusted as follows:

1. Wire an AC RMS ammeter in series with one motor phase.
2. Run the motor unloaded at approximately 4 Hz (or 120 RPM).
3. Increase the boost until the ammeter reaches the motor nameplate rated current (Amps AC).
4. Using the Main Speed Potentiometer, slowly adjust the motor speed over a 1 – 15 Hz (0 – 450 RPM) range. If the motor current exceeds the nameplate rating, decrease the boost setting.

Figure 43 – Jog Trimpot Range

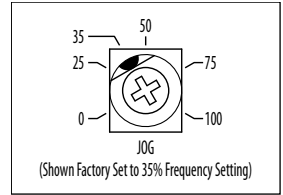

13.9 Jog (JOG) – The Jog feature requires the installation of a Run-Stop-Jog Switch. The switch must be wired according to Figure 44. The JOG Trimpot range is shown in Figure 43.

The orange Main Speed Potentiometer wire (wiper) which connects to Terminal “P2” on the drive must be removed and installed on Terminal “RUN” on the switch. The “JOG” Terminal on the drive connects to “JOG” on the switch. Terminal “P2” on the drive connects to the center (common) terminal on the switch.

When the switch is in the “JOG” position, the JOG Trimpot is used to set the “jog” speed. When the switch is in the “RUN” position, the Main Speed Potentiometer is used for speed setting.

The Run-Stop-Jog Switch is available as an optional accessory. See Table 2 on page 9.

Figure 44 – Run-Stop-Jog Switch Connection (SPDT – Center Off)*

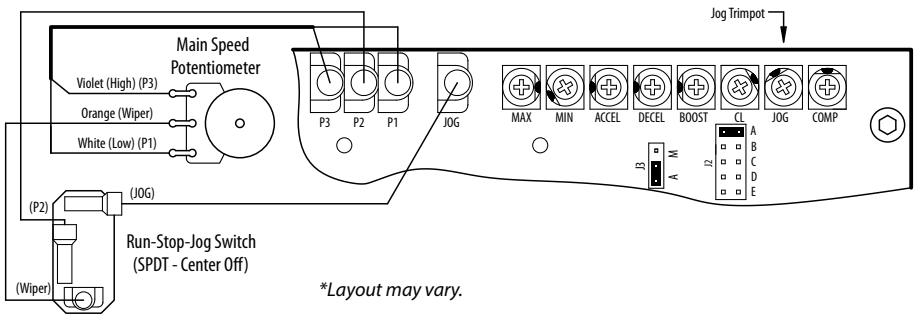

*Layout may vary.

APPENDIX A – Optional SIAC-PS Signal Isolator with Power Supply

See SIAC-PS Installation Instructions for details and connections.

Description

The SIAC-PS Signal Isolator with Power Supply provides an isolated interface between non-isolated signal sources and the drive. It is used to isolate, amplify, and condition DC voltage and current signals from any source (tach-generators, transducers, PLCs, and potentiometers). It provides an isolated input to control motor direction and an isolated 5 Volt DC power supply for potentiometer operation. In addition, this updated model contains an isolated 24 Volt DC power supply for transducers or auxiliary equipment. All input connections and power supplies are isolated from the AC Line and motor wiring. It installs easily into the drive with a snap-in mounting base and is wired with a connector.

Main features include voltage or current signal inputs. Other features include a power on LED, barrier terminal blocks to facilitate wiring, multi-turn trimpots (MAX1, OFFSET), and a jumper for voltage or current signal input selection. An optional accessory for use with the SIAC-PS is the Auto/Manual Switch to select a signal input from either the SIAC-PS or the Main Speed Potentiometer of the drive.

Table 1 – General Performance Specifications

Parameter	Specification	Factory Setting
Maximum Speed Trimpot (MAX1) Input Voltage Range (Volts DC)	0 to 2.5 thru 0 to 25	0 to 5
Offset Trimpot (OFFSET) Range (% of MAX1 Trimpot Setting)	0 – ±50	0
Input Current Range (milliamps DC)	4 – 20	—
Forward and Reverse Input Switch Types	Dry Contact or Open Collector	—
5 Volt DC Power Supply Maximum Load Current Rating (milliamps DC)	1	—
24 Volt DC Power Supply Maximum Load Current Rating (milliamps DC)	50	—
Potentiometer Operation (kΩ)	5	—
Input/Output Linearity (%)	0.1	—
Thermal Drift (millivolts per °C)	0.4	—
Operating Temperature Range (°C / °F)	0 – 40 / 32 – 104	—
Operating Humidity Range (% Relative, Non-Condensing)	0 – 95	—
Storage Temperature (°C / °F)	-25 – +85 / -13 – +185	—

Figure 1 – SIAC-PS Layout and Descriptions*

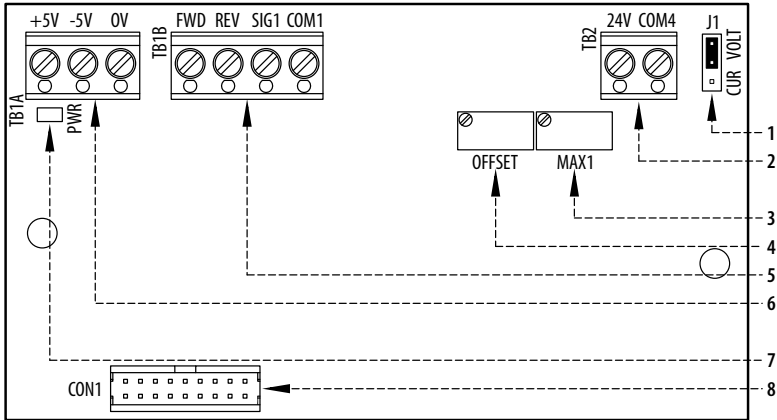

*Layout may vary.

No.	Description
1	J1: Sets the drive for operation with a voltage or current signal input.
2	TB2: Isolated 24 Volt DC power supply. Used for powering transducers or auxiliary equipment.
3	MAX1: Maximum signal input adjustment trimpot.
4	OFFSET: Signal Offset adjustment trimpot.
5	TB1B: Potentiometer or Signal Input and Direction Switch connections.
6	TB1A: Isolated 5 Volt DC power supply. Can be used for Main Speed Potentiometer operation.
7	PWR: Power On LED.
8	CON1: Used for the Ribbon Cable to connect the SIAC-PS to the drive.

– Notes –